

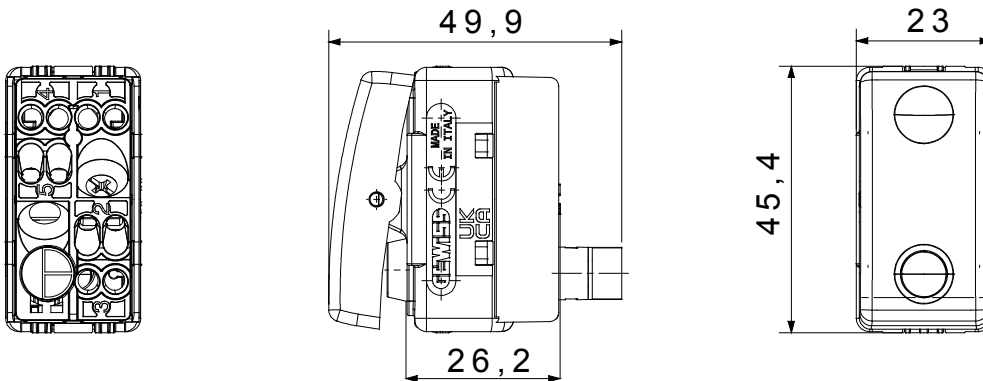

The System modular devices allow the creation of infinite combinations of devices and plates, through a complete range that covers all design, functional and installation needs. Colours and finishes: satin black, elegant and classy. Ideal for flush-mounted solutions (for rectangular or square boxes), surface-mounted solutions and special applications. The range includes control units, socket-outlets, breakers, indicators, connectors and devices for the control, safety and comfort of your home

Category	One-way switch	Button key	With replaceable neutral lens
Symbol	-	Colour	Black
Description	1P - 16 AX backlit	Voltage	250 V ac
Signalling unit	Miniature lamp - Fluorescent - 230Vac - 0,4W - Red	Standard	EN 60669-1
Resistance at test voltage	2000 V at 50 Hz for 1 minute	Rated power of 230V LED lamps	200 W
Insulation resistance	> 5 MOhm	Wiring terminals	With screw
Prolonged operation switch (no.of position changes)	40.000 at In 250 V ac cosφ=0,6	Thermo-pressure with ball	125 °C
Glow Wire Test	850 °C	Terminal grip on cable traction	> 50 N
Terminal tightening capacity stranded cables (mm ²)	min. 0,75 - max. 2x4	Terminal tightening capacity solid cables (mm ²)	min. 0,5 - max. 2x2,5
No. SYSTEM modules	1	Material	Technopolymer
Electrocod	0130		

DIMENSIONAL



TECHNICAL SYMBOLOGY



STANDARDS/APPROVALS

