

Range of plates available in 9 colour tones and 3 finishes: glossy, satin, and matric. Compatible with rectangular boxes up to 12 modules. The plates, with a completely flat surface, blend elegantly with the geometry of the commands, offering understated and modern solutions for any environment. The themed lines in monochrome, natural and neutral tones enhance spaces with discretion, meeting the needs of any environment. The offering also includes watertight IP55 plates in 3 and 4 modules formats. The frontal installation of devices simplifies every work, allowing the attachment and release without removing the support from the flush-mounted box. A solution designed to simplify changes and updates, reducing intervention time.

Category	Support	Description	2 modules
Fixing	2 screws (included)	Type of screw	6/32 x 21,5 mm
Standard	EN 60669-1	Thermo-pressure with ball	70 °C
Glow Wire Test	650 °C	Material	Technopolymer
Halogen Free	Halogen-free in compliance with EN IEC 63355	Electrocod	0121

DIMENSIONAL

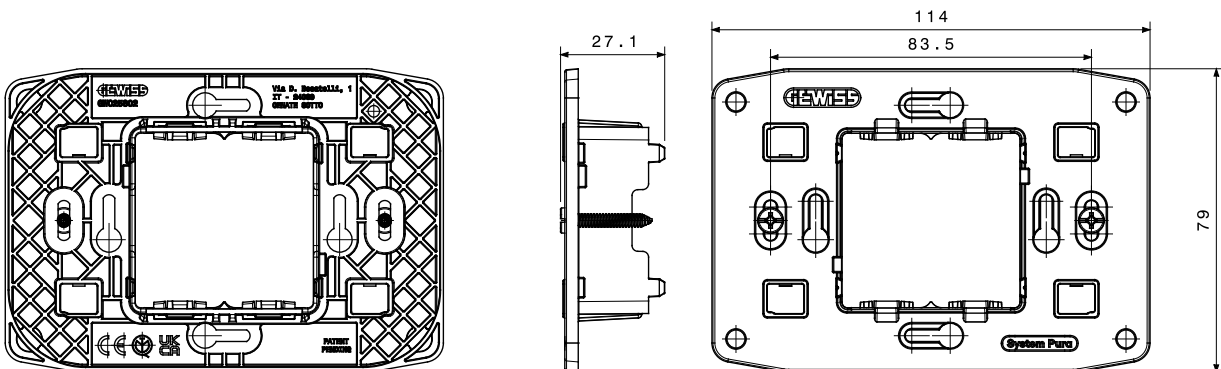

TECHNICAL SYMBOLOGY



STANDARDS/APPROVALS

