

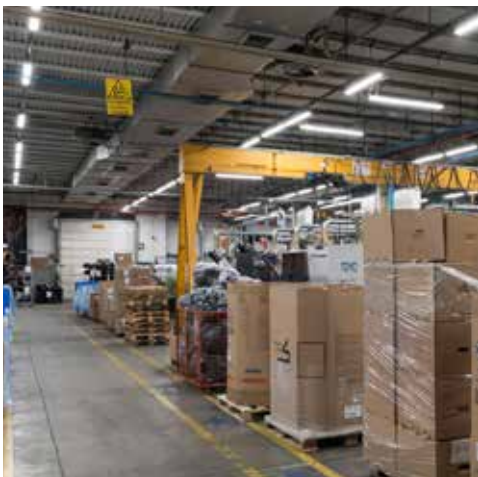

Smart [3] Plus Smart [3]

GEWISS



Ed. **03**
2021

CONTENTS

- 4 Smart [3] Plus and Smart [3]
- 8 Product Range
- 10 Benefits
- 16 Technical Features
- 20 Smart [3] Plus
- 36 Smart [3]
- 44 Installation Methods and Benefits
- 46 GEWISS Services



Smart [3] Plus Smart [3]

Introducing **Smart [3] Plus!** Offering greater lighting performance and improved efficiency for even better energy savings. This new range of products is a

welcome addition to the feature-rich **Smart [3]** family, offering an even more complete range of products for car parks, industrial areas, warehouses and more!

Smart [3] Plus

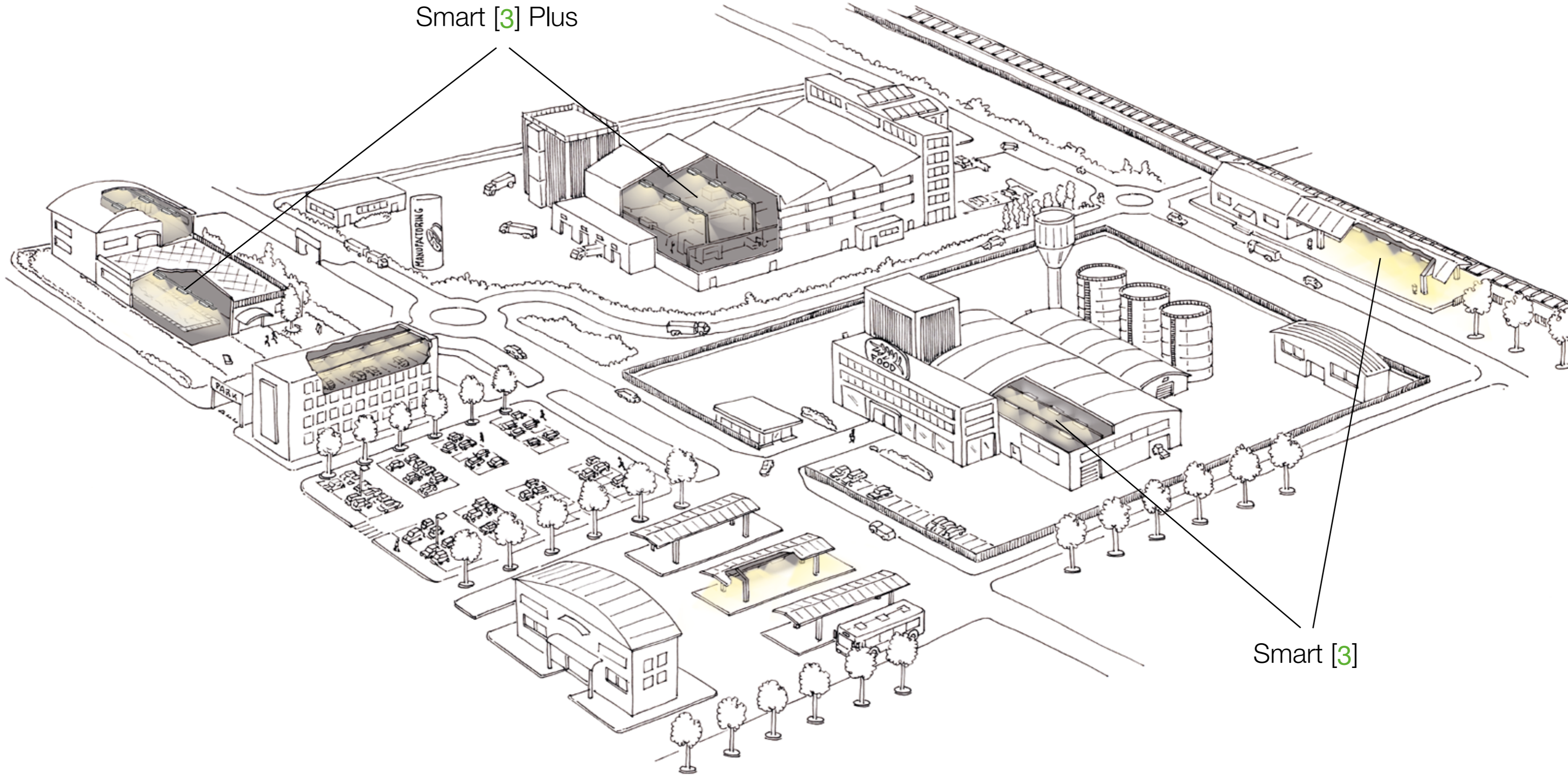

Smart [3]

PRODUCT RANGE



Smart [3] Plus

The **Smart [3] Plus** range offers a variety of watertight LED ceiling lights, made using an entirely polycarbonate construction. Suitable for installation up to 2-9 metres high, and entirely designed, developed and manufactured in Italy. The product range features a sleek design that emphasises the unique features of the new LED technology, offering extremely low energy consumption, high impact resistance and simple installation. The LED lights can replace high-flux fluorescents and lowbays up to 10,000 lm. High flow rates allow the user to reduce the amount of pre-installed equipment, while maintaining the same lighting level.



Smart [3]

The **Smart [3]** range offers a variety of watertight LED ceiling lights, with an entirely polycarbonate construction. Suitable for low-level installation (up to 4 metres), and entirely designed, developed and manufactured in Italy. The product range features a sleek design that emphasises the unique features of new LED technology, offering extremely low energy consumption, high impact resistance and simple installation. The LED lights can replace all versions of linear fluorescent watertight lights from 18W to 58W, both in single-lamp and dual-lamp versions.

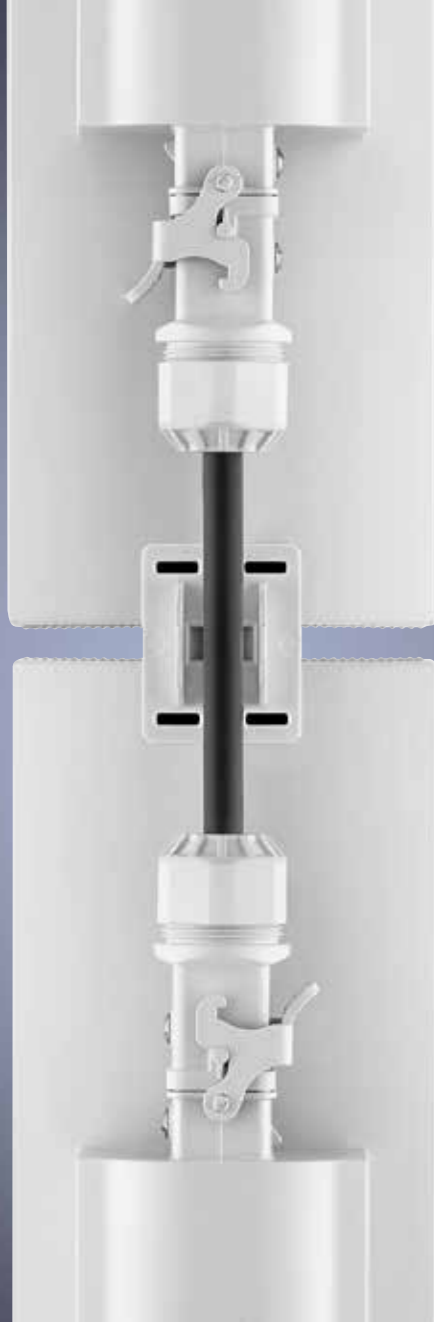

Smart [3] Plus Smart [3]

MODULARITY

Smart [3] Plus and Smart [3] are available in three sizes, in a Stand Alone or Through Wiring version, for easy and quick installation and can be mains or battery powered.

FLEXIBILITY

The Smart [3] family is growing, and is now more flexible than ever, thanks to Smart [3] Plus. With a variety of power levels, high efficiency and high emission versions (HLO), as well as a new Medium Beam option, the range can meet any lighting and application needs.

CONNECTIVITY

Smart [3] Plus and Smart [3] are designed to dialogue with IoT systems, allowing the user to monitor consumption, ignition, programming and efficiency tests. For an increasingly SMART system.

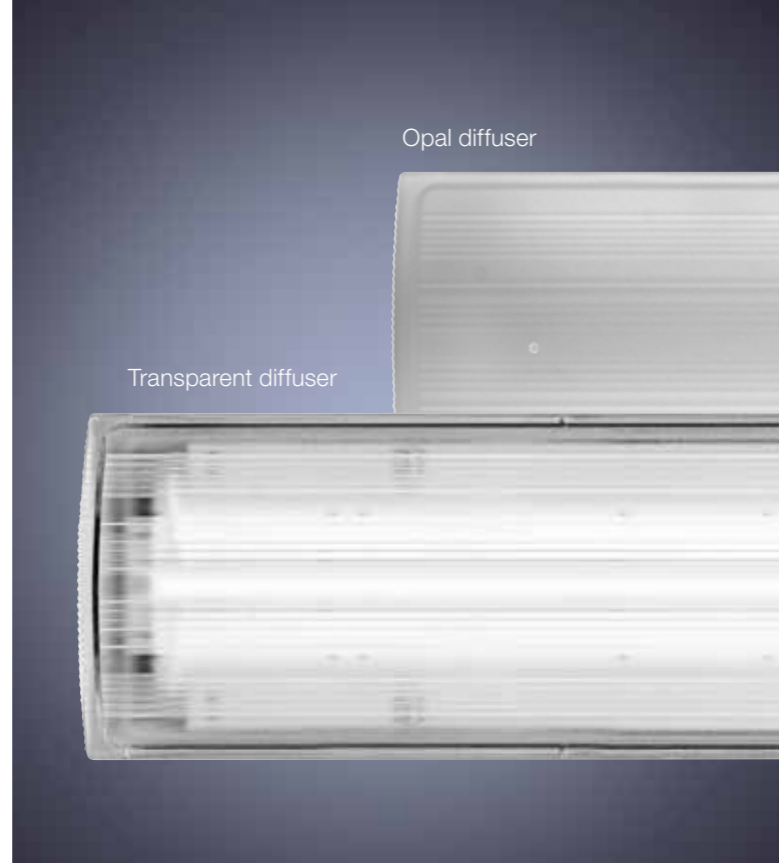

Red Dot Award

With a compact and minimal design, using advanced technologies and quality LEDs, **Smart [3]** was awarded the prestigious Red Dot Award 2017, for Product Design. Aesthetics, intelligence, technology, green credentials and an ongoing evolution of the range, including the introduction of **Smart [3] Plus** are key to this product's success.

Two families, three sizes, two finishes

The **Smart [3]** family, available in three sizes (800 mm, 1200 mm and 1600 mm), is now extended with the introduction of the new **Smart [3] Plus** range, with ever increasing lighting performance and even higher energy savings. The complete range is available in transparent or opal screen versions, in three colour temperatures (3000K, 4000K, 5700K) and two Color Rendering Index types (CRI>80, CRI >90). The range is available in an On/Off version or with DALI power supply (DALI 2) and can be installed as a Stand Alone version, or in a continuous row with Through Wiring connection. **Smart [3] Plus** also includes versions with an integrated lens and HLO (High Lumen Output).

Increased lighting performance

Smart [3] Plus, with its high flows (up to 9400lm effective) is also available in a version with integrated lens with medium beam or elliptical beam light distribution. Thanks to an accurate optical study and GEWISS' expertise in moulding high-performance technopolymers, **Smart [3] Plus** can meet any lighting requirements and can also be used in applications at heights greater than 4 metres.

Design Made in Italy

Smart [3] Plus and **Smart [3]** are elegant and efficient products, designed specifically to adapt to the compact dimensions of new LED technology and restore a touch of elegance and lightness in every application context. The range features a Slim design, in which every detail has been carefully studied to ensure the highest standards of watertight LED ceiling lights. Made in Italy design and production guarantee style, efficiency, long life and high levels of protection and safety.

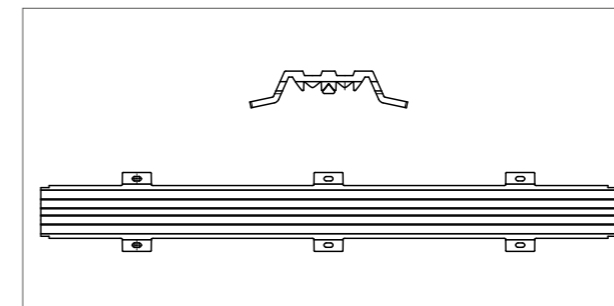
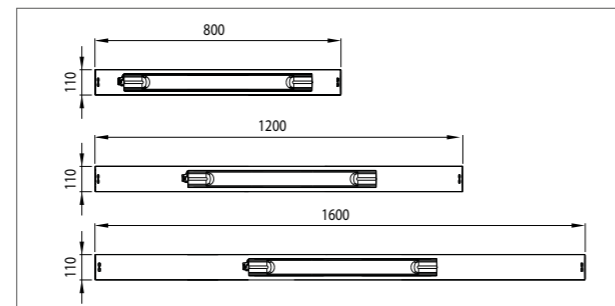

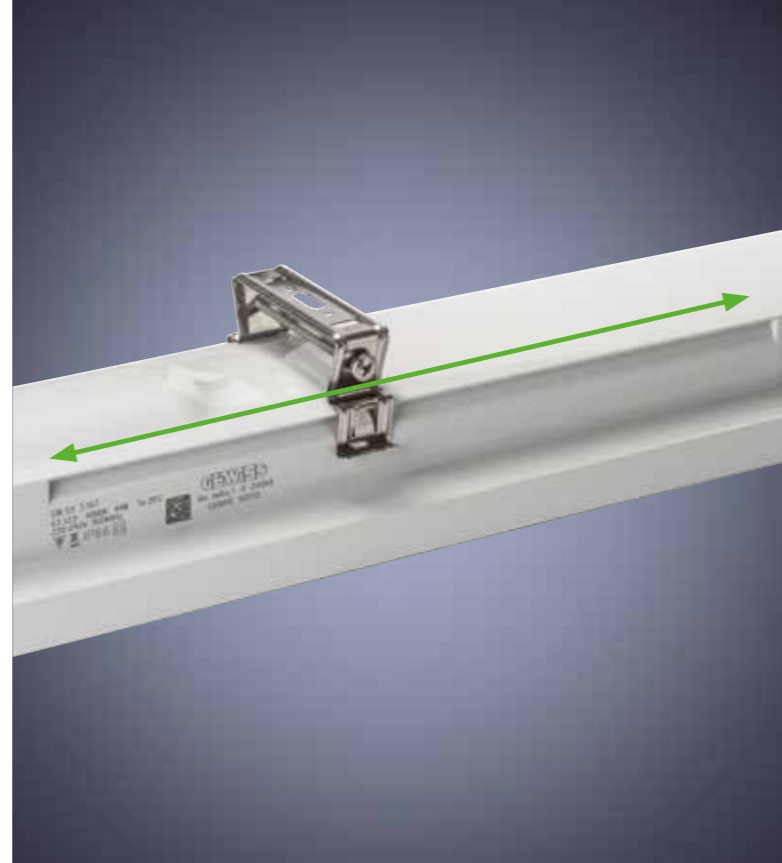

Next generation LEDs

Using a new LED that has never been used on watertight ceiling lights has been selected for the **Smart [3] Plus** family. A new generation of LED with a Flip Chip structure, which provides greater mechanical resistance as there is no wire-bonding connection. Inside, the PCT plastic reflector with silver metallisation has been replaced by titanium dioxide to avoid sulphur contamination. A high performance LED that ensures excellent product reliability and long life, even in critical environments.

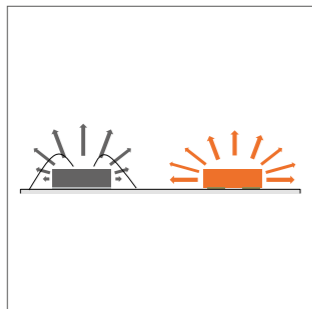

Easy installation

Smart [3] Plus and **Smart [3]** fittings are extremely versatile and easy to install, durable and safe. The products can be paired with an accessory providing variable fixing points, and relative guides are integrated into the design of the fitting, allowing these lighting fixtures to be installed anywhere and into pre-existing systems, simply and without having to modify the existing system.

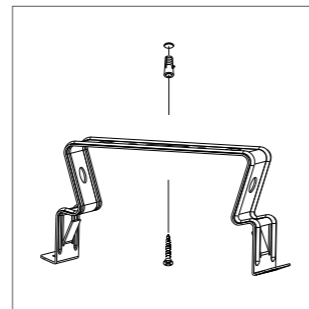

High quality performance

Smart [3] Plus and **Smart [3]** are constructed entirely from polycarbonate and are suitable for installation at heights of up to 8-9 m. The entire range has the highest degree of protection against dust or liquid penetration (IP69) as well as high impact resistance (IK08).

Available in three different sizes, **the Smart [3] family** offers a wide choice of light flows, emitting up to 9,400lm with an efficiency of 163lm/W in the 1,600 mm **Smart [3] Plus** version, offering increased lighting performance with a lifetime greater than 50,000h L90B10 and greater than 100,000h L80B10, with Tq 25°.

up to 9400 lm	up to 163 lm/W
IP 69	IK 08

Ideal for special applications

The accessory, which can be purchased separately, consists of two brackets that can be attached to any **Smart [3] Plus** and **Smart [3]** model. The watertight ceiling light can be used in harsh environments where accurate mechanical installation is required. **Smart [3] Plus** and **Smart [3]** can be used in marine environments and in some applications where oil-based substances are present - please check your requirement with our internal lighting design team before purchasing.

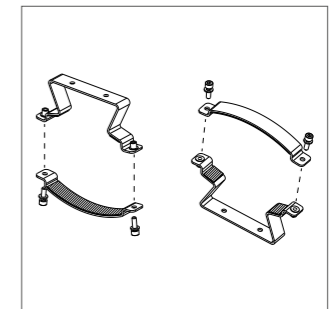

Smart [3] Plus



Optics	Transparent microprismatic Opal Transparent with internal lens		
Glare and luminance control	UGR ≤ 25		
Device luminous flux	from 2700 lm to 3900 lm	from 4000 lm to 5700 lm	from 5200 lm to 9400 lm
Luminous efficiency	from 104 lm/W to 156lm/W	from 105 lm/W to 158 lm/W	from 104 lm/W to 163 lm/W
Colour temperature	3,000K/4,000K/5,700K		
Colour rendering index	CRI>80/CRI>90		
Power consumption	up to 26W	up to 38W	up to 63W
Standard deviation colour matching	SDCM = 3		
Lifetime	L90B10 (Tq+25°C) = 50,000h L90B10 (Tq+50°C) = 45,000h L80B10 (Tq+25°C) = 100,000h		
Photobiological class	RG0		
Weight	1.7 kg	2.4 kg	4.0 kg
Power voltage	220÷240V		
Operating temperature	-25°C ÷ +50 °C		
Rated frequency	50/60 Hz		
Protection device	DM 1KV/CM 2KV		
Control System/Wiring	Stand Alone - On / Off Stand Alone - DALI Through Wiring - On/Off Through Wiring - DALI Integrated Emergency		
Insulation class	II		
Protection degree	IP66/IP69		
Impact resistance	IK08		
Glow wire test	850°C		

Smart [3]



Optics	Transparent microprismatic Opal		
Glare and luminance control	UGR ≤ 22/UGR ≤ 25	UGR ≤ 25	UGR ≤ 25
Device luminous flux	from 1600 lm to 3400 lm	from 2500 lm to 5200 lm	from 3250 lm to 6700 lm
Luminous efficiency	from 107 lm/W to 126 lm/W	from 125 lm/W to 130 lm/W	from 122 lm/W to 134 lm/W
Colour temperature	3,000K/4,000K/5,700K		
Colour rendering index	CRI>80		
Power consumption	up to 27W	up to 40W	up to 50W
Standard deviation colour matching	SDCM = 3		
Lifetime	L90B50 (Tq+25°C) = 50,000h L80B10 (Tq+25°C) = 100,000h		
Photobiological class	RG0		
Weight	1.7 kg	2.4 kg	4.0 kg
Power voltage	220÷240V		
Operating temperature	-25°C ÷ +50 °C		
Rated frequency	50/60 Hz		
Protection device	DM 1KV/CM 2KV		
Control System/Wiring	Stand Alone - On / Off Stand Alone - DALI Through Wiring - On/Off Through Wiring - DALI		
Insulation class	II		
Protection degree	IP66/IP69		
Impact resistance	IK08		
Glow wire test	850°C		



Smart [3] Plus
Smart [3]



Smart [3] Plus

Watertight LED ceiling light with high-performance lighting and exceptional energy savings.

Smart [3] Plus is a watertight LED ceiling light for industrial applications, ideal for production areas, warehouses and logistics areas. The unit can be installed on ceilings using spring clips with adjustable quick fix coupling, which allow for a wide range of axes, so you can use existing fixing points. The fitting can be suspended or wall mounted. For wall installation, the Gw bracket accessory is also available so this watertight appliance can be orientated on a vertical axis, at a 30° and 45° angle. The Through-Wiring version is already equipped with pre-wired mechanical and electrical connection components. The maximum number of fittings that can be installed in a continuous row is 25. Polycarbonate construction, in grey RAL7035. Available in 3 sizes and powers, with integrated power in the On/Off or DALI versions. Three different optics: Transparent, Opal and Transparent with medium-beam optics screen, that includes a TIR lens made of PMMA. The fittings, which range from 4,000lm to 10,000lm, can replace high flux fluorescents and lowbay lights, up to 10,000 lm. High flow rates means the number of fittings can be reduced, while maintaining the same lighting level, with installation up to 8-9 metres high.

-  IP 66
-  IP 69
-  IK 08
-  GWT 850°C
-  CE
-  EN
-  5 YEARS

APPLICATIONS



Warehouses



Transport stops

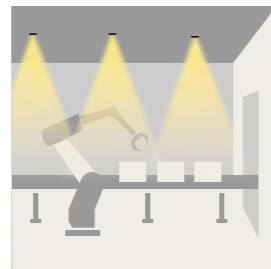

Production Lines

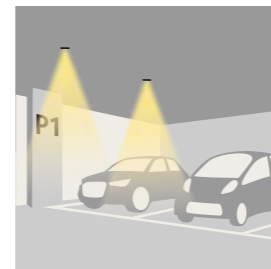

Car parks

LIGHT BEAM DISTRIBUTION

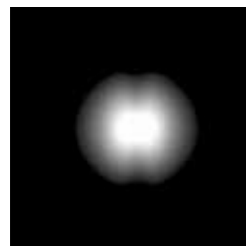

T - Transparent



P - Opal

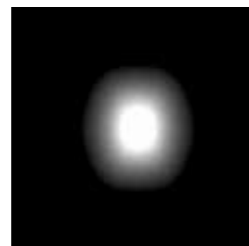

C - Transparent
Medium Beam



B - Elliptical
beam

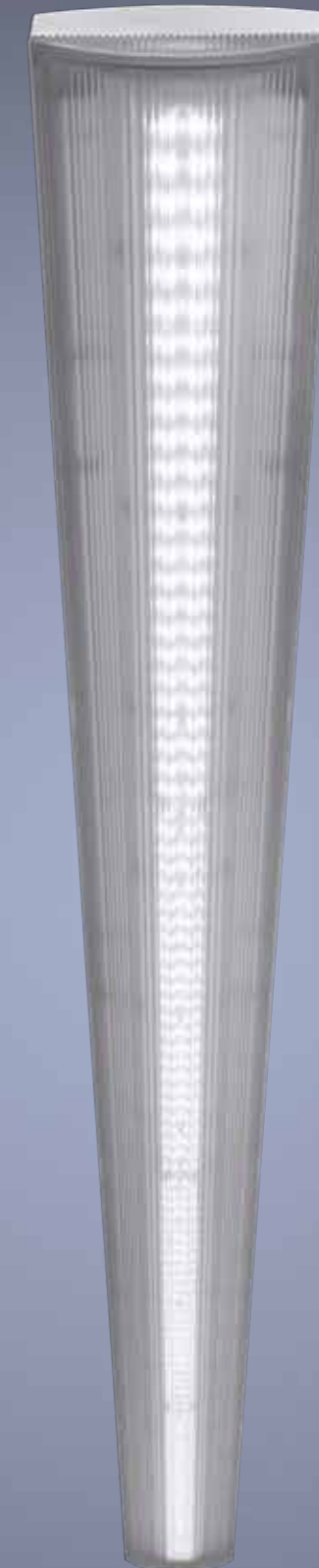



SIZE

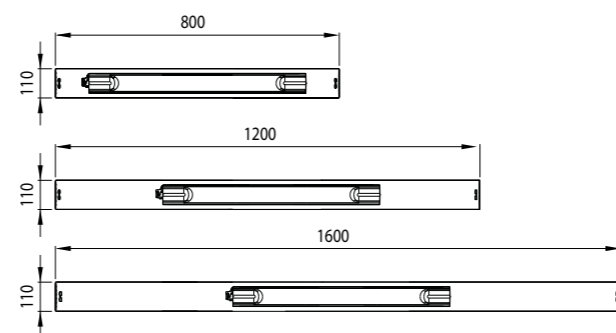

PHOTOMETRY

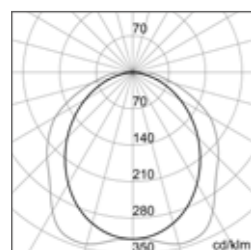

T - Transparent

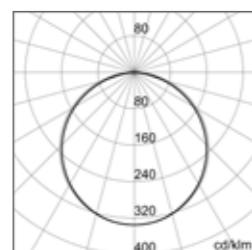

P - Opal

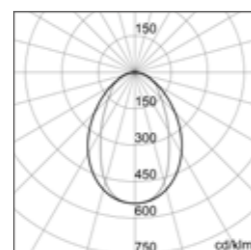

C - Transparent medium beam

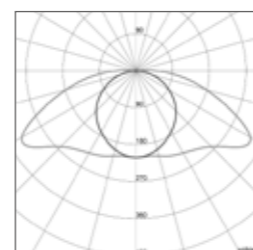

B - Elliptical beam

GENERAL INFORMATION

Recommended installation height	Up to 8-9 m
Relamping	Range from 4000lm to 10000lm available in three sizes. The LED lights can replace high-flux fluorescents and low bays up to 10,000 lm. High flow rates allow the user to reduce the amount of pre-installed equipment, while maintaining the same lighting level.
Body	Self-extinguishing polycarbonate coloured in grey RAL7035
Diffuser	UV-stabilised self-extinguishing polycarbonate with excellent transmittance in opal or transparent finish
Lens	Available with Medium or Elliptical Beam optics using a TIR lens made from PMMA.
Sealing	The coupling between the unit and the diffuser is made with two-component polyurethane sealant to ensure a stable seal over time
LED technology	Flip Type without wire bonding
LED internal reflector	In titanium dioxide resistant to sulphur contamination
Electrical connection	The electrical connector is equipped with a quick, ergonomic connection system for cables with up to 1.5 mm ² section and a side safety, lever-driven device.
Installation	The ceiling light can be installed on the ceiling using spring clips with adjustable quick fix coupling, which allows for a wide range of axes, thus allowing the reuse of existing fixing points. The device can be suspended or wall mounted. For wall installation, the GEWISS Bracket accessory is also available, which allows the watertight appliance to be orientated on the vertical axis, at a 30° and 45° angle. The Through Wiring version is already equipped with pre-wired mechanical and electrical connection components. The maximum number of devices installed in a continuous row is 25.
Emergency	The Smart [3] Plus range is available in an emergency version. The Emergency function comes in three different modes: <ul style="list-style-type: none"> • under UPS with the latest driver • with an external emergency kit that can be purchased as an accessory, only for the Through Wiring versions; • with Integrated Emergency version, for 1200 and 1600 versions only.



Smart [3] Plus | 800

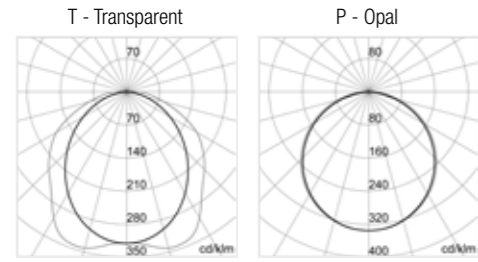

OPAL DIFFUSER

Code	Control system	Cabling	Colour temp. (CCT)	Colour rendering index (CRI)	Luminous flux of the device (lm)	Power consumption (W)	Efficiency (lm/W)
GWS3120AP830	On/Off	Stand Alone	3,000K	CRI>80	3500	25	140
GWS3120AP840	On/Off	Stand Alone	4,000K	CRI>80	3700	25	148
GWS3120AP857	On/Off	Stand Alone	5,700K	CRI>80	3700	25	148
GWS3120AP930	On/Off	Stand Alone	3,000K	CRI>90	2700	25	108
GWS3120AP940	On/Off	Stand Alone	4,000K	CRI>90	2900	25	116
GWS3120AP957	On/Off	Stand Alone	5,700K	CRI>90	2900	25	116
GWS3122AP830	On/Off	Through Wiring	3,000K	CRI>80	3500	25	140
GWS3122AP840	On/Off	Through Wiring	4,000K	CRI>80	3700	25	148
GWS3122AP857	On/Off	Through Wiring	5,700K	CRI>80	3700	25	148
GWS3122AP930	On/Off	Through Wiring	3,000K	CRI>90	2700	25	108
GWS3122AP940	On/Off	Through Wiring	4,000K	CRI>90	2900	25	116
GWS3122AP957	On/Off	Through Wiring	5,700K	CRI>90	2900	25	116
GWS3121AP830	DALI	Stand Alone	3,000K	CRI>80	3500	26	135
GWS3121AP840	DALI	Stand Alone	4,000K	CRI>80	3700	26	142
GWS3121AP857	DALI	Stand Alone	5,700K	CRI>80	3700	26	142
GWS3121AP930	DALI	Stand Alone	3,000K	CRI>90	2700	26	104
GWS3121AP940	DALI	Stand Alone	4,000K	CRI>90	2900	26	112
GWS3121AP957	DALI	Stand Alone	5,700K	CRI>90	2900	26	112
GWS3123AP830	DALI	Through Wiring	3000K	CRI>80	3500	26	135
GWS3123AP840	DALI	Through Wiring	4,000K	CRI>80	3700	26	142
GWS3123AP857	DALI	Through Wiring	5,700K	CRI>80	3700	26	142
GWS3123AP930	DALI	Through Wiring	3,000K	CRI>90	2700	26	104
GWS3123AP940	DALI	Through Wiring	4,000K	CRI>90	2900	26	112
GWS3123AP957	DALI	Through Wiring	5,700K	CRI>90	2900	26	112

TRANSPARENT DIFFUSER

Code	Control system	Cabling	Colour temp. (CCT)	Colour rendering index (CRI)	Luminous flux of the device (lm)	Power consumption (W)	Efficiency (lm/W)
GWS3120AT830	On/Off	Stand Alone	3,000K	CRI>80	3700	25	148
GWS3120AT840	On/Off	Stand Alone	4,000K	CRI>80	3900	25	156
GWS3120AT857	On/Off	Stand Alone	5,700K	CRI>80	3900	25	156
GWS3120AT930	On/Off	Stand Alone	3,000K	CRI>90	2900	25	116
GWS3120AT940	On/Off	Stand Alone	4,000K	CRI>90	3100	25	124
GWS3120AT957	On/Off	Stand Alone	5,700K	CRI>90	3100	25	124
GWS3122AT830	On/Off	Through Wiring	3,000K	CRI>80	3700	25	148
GWS3122AT840	On/Off	Through Wiring	4,000K	CRI>80	3900	25	156
GWS3122AT857	On/Off	Through Wiring	5,700K	CRI>80	3900	25	156
GWS3122AT930	On/Off	Through Wiring	3,000K	CRI>90	2900	25	116
GWS3122AT940	On/Off	Through Wiring	4,000K	CRI>90	3100	25	124
GWS3122AT957	On/Off	Through Wiring	5,700K	CRI>90	3100	25	124
GWS3121AT830	DALI	Stand Alone	3,000K	CRI>80	3700	26	142
GWS3121AT840	DALI	Stand Alone	4,000K	CRI>80	3900	26	150
GWS3121AT857	DALI	Stand Alone	5,700K	CRI>80	3900	26	150
GWS3121AT930	DALI	Stand Alone	3,000K	CRI>90	2900	26	112
GWS3121AT940	DALI	Stand Alone	4,000K	CRI>90	3100	26	119
GWS3121AT957	DALI	Stand Alone	5,700K	CRI>90	3100	26	119
GWS3123AT830	DALI	Through Wiring	3,000K	CRI>80	3700	26	142
GWS3123AT840	DALI	Through Wiring	4,000K	CRI>80	3900	26	150
GWS3123AT857	DALI	Through Wiring	5,700K	CRI>80	3900	26	150
GWS3123AT930	DALI	Through Wiring	3,000K	CRI>90	2900	26	112
GWS3123AT940	DALI	Through Wiring	4,000K	CRI>90	3100	26	119
GWS3123AT957	DALI	Through Wiring	5,700K	CRI>90	3100	26	119

Smart [3] Plus | 1200

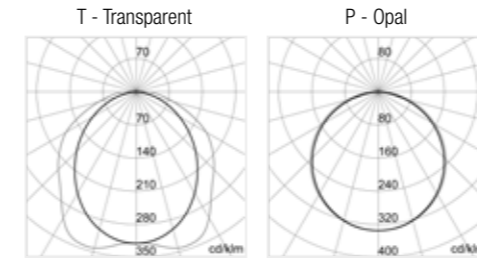

OPAL DIFFUSER

Code	Control system	Cabling	Colour temp. (CCT)	Colour rendering index (CRI)	Luminous flux of the device (lm)	Power consumption (W)	Efficiency (lm/W)
GWS3220AP830	On/Off	Stand Alone	3,000K	CRI>80	5100	36	142
GWS3220AP840	On/Off	Stand Alone	4,000K	CRI>80	5400	36	150
GWS3220AP857	On/Off	Stand Alone	5,700K	CRI>80	5400	36	150
GWS3220AP930	On/Off	Stand Alone	3,000K	CRI>90	4000	36	111
GWS3220AP940	On/Off	Stand Alone	4,000K	CRI>90	4200	36	117
GWS3220AP957	On/Off	Stand Alone	5,700K	CRI>90	4200	36	117
GWS3222AP830	On/Off	Through Wiring	3,000K	CRI>80	5100	36	142
GWS3222AP840	On/Off	Through Wiring	4,000K	CRI>80	5400	36	150
GWS3222AP857	On/Off	Through Wiring	5,700K	CRI>80	5400	36	150
GWS3222AP930	On/Off	Through Wiring	3,000K	CRI>90	4000	36	111
GWS3222AP940	On/Off	Through Wiring	4,000K	CRI>90	4200	36	117
GWS3222AP957	On/Off	Through Wiring	5,700K	CRI>90	4200	36	117
GWS3221AP830	DALI	Stand Alone	3,000K	CRI>80	5100	38	134
GWS3221AP840	DALI	Stand Alone	4,000K	CRI>80	5400	38	142
GWS3221AP857	DALI	Stand Alone	5,700K	CRI>80	5400	38	142
GWS3221AP930	DALI	Stand Alone	3,000K	CRI>90	4000	38	105
GWS3221AP940	DALI	Stand Alone	4,000K	CRI>90	4200	38	111
GWS3221AP957	DALI	Stand Alone	5,700K	CRI>90	4200	38	111
GWS3223AP830	DALI	Through Wiring	3,000K	CRI>80	5100	38	134
GWS3223AP840	DALI	Through Wiring	4,000K	CRI>80	5400	38	142
GWS3223AP857	DALI	Through Wiring	5,700K	CRI>80	5400	38	142
GWS3223AP930	DALI	Through Wiring	3,000K	CRI>90	4000	38	105
GWS3223AP940	DALI	Through Wiring	4,000K	CRI>90	4200	38	111
GWS3223AP957	DALI	Through Wiring	5,700K	CRI>90	4200	38	111

TRANSPARENT DIFFUSER

Code	Control system	Cabling	Colour temp. (CCT)	Colour rendering index (CRI)	Luminous flux of the device (lm)	Power consumption (W)	Efficiency (lm/W)
GWS3220AT830	On/Off	Stand Alone	3,000K	CRI>80	5400	36	150
GWS3220AT840	On/Off	Stand Alone	4,000K	CRI>80	5700	36	158
GWS3220AT857	On/Off	Stand Alone	5,700K	CRI>80	5700	36	158
GWS3220AT930	On/Off	Stand Alone	3,000K	CRI>90	4200	36	117
GWS3220AT940	On/Off	Stand Alone	4,000K	CRI>90	4500	36	125
GWS3220AT957	On/Off	Stand Alone	5,700K	CRI>90	4500	36	125
GWS3222AT830	On/Off	Through Wiring	3,000K	CRI>80	5400	36	150
GWS3222AT840	On/Off	Through Wiring	4,000K	CRI>80	5700	36	158
GWS3222AT857	On/Off	Through Wiring	5,700K	CRI>80	5700	36	158
GWS3222AT930	On/Off	Through Wiring	3,000K	CRI>90	4200	36	117
GWS3222AT940	On/Off	Through Wiring	4,000K	CRI>90	4500	36	125
GWS3222AT957	On/Off	Through Wiring	5,700K	CRI>90	4500	36	125
GWS3221AT830	DALI	Stand Alone	3,000K	CRI>80	5400	38	142
GWS3221AT840	DALI	Stand Alone	4,000K	CRI>80	5700	38	150
GWS3221AT857	DALI	Stand Alone	5,700K	CRI>80	5700	38	150
GWS3221AT930	DALI	Stand Alone	3,000K	CRI>90	4200	38	111
GWS3221AT940	DALI	Stand Alone	4,000K	CRI>90	4500	38	118
GWS3221AT957	DALI	Stand Alone	5,700K	CRI>90	4500	38	118
GWS3223AT830	DALI	Through Wiring	3,000K	CRI>80	5400	38	142
GWS3223AT840	DALI	Through Wiring	4,000K	CRI>80	5700	38	150
GWS3223AT857	DALI	Through Wiring	5,700K	CRI>80	5700	38	150
GWS3223AT930	DALI	Through Wiring	3,000K	CRI>90	4200	38	111
GWS3223AT940	DALI	Through Wiring	4,000K	CRI>90	4500	38	118
GWS3223AT957	DALI	Through Wiring	5,700K	CRI>90	4500	38	118

Smart [3] Plus | 1200 INTEGRATED EMERGENCY

OPAL DIFFUSER

Code	Control system	Cabling	Colour temp. (CCT)	Colour rendering index (CRI)	Luminous flux of the device (lm)	Power consumption (W)	Efficiency (lm/W)
GWS3225AP830	1 x DALI DT6 + 1 x DALI DT1 (Emerg. 3h)	Stand Alone	3.000K	CRI>80	5100 (560 Em.)	38W (+5W Emerg.)	109
GWS3225AP840	1 x DALI DT6 + 1 x DALI DT1 (Emerg. 3h)	Stand Alone	4.000K	CRI>80	5400 (600 Em.)	38W (+5W Emerg.)	116
GWS3225AP857	1 x DALI DT6 + 1 x DALI DT1 (Emerg. 3h)	Stand Alone	5.700K	CRI>80	5400 (600 Em.)	38W (+5W Emerg.)	116
GWS3225AP930	1 x DALI DT6 + 1 x DALI DT1 (Emerg. 3h)	Stand Alone	3.000K	CRI>80	4000 (440 Em.)	38W (+5W Emerg.)	86
GWS3225AP940	1 x DALI DT6 + 1 x DALI DT1 (Emerg. 3h)	Stand Alone	4.000K	CRI>80	4200 (460 Em.)	38W (+5W Emerg.)	91
GWS3225AP957	1 x DALI DT6 + 1 x DALI DT1 (Emerg. 3h)	Stand Alone	5.700K	CRI>80	4200 (460 Em.)	38W (+5W Emerg.)	91

TRANSPARENT DIFFUSER

Code	Control system	Cabling	Colour temp. (CCT)	Colour rendering index (CRI)	Luminous flux of the device (lm)	Power consumption (W)	Efficiency (lm/W)
GWS3225AT830	1 x DALI DT6 + 1 x DALI DT1 (Emerg. 3h)	Stand Alone	3.000K	CRI>80	5400 (600 Em.)	38W (+5W Emerg.)	126
GWS3225AT840	1 x DALI DT6 + 1 x DALI DT1 (Emerg. 3h)	Stand Alone	4.000K	CRI>80	5700 (630 Em.)	38W (+5W Emerg.)	133
GWS3225AT857	1 x DALI DT6 + 1 x DALI DT1 (Emerg. 3h)	Stand Alone	5.700K	CRI>80	5700 (630 Em.)	38W (+5W Emerg.)	133
GWS3225AT930	1 x DALI DT6 + 1 x DALI DT1 (Emerg. 3h)	Stand Alone	3.000K	CRI>80	4200 (460 Em.)	38W (+5W Emerg.)	98
GWS3225AT940	1 x DALI DT6 + 1 x DALI DT1 (Emerg. 3h)	Stand Alone	4.000K	CRI>80	4500 (500 Em.)	38W (+5W Emerg.)	105
GWS3225AT957	1 x DALI DT6 + 1 x DALI DT1 (Emerg. 3h)	Stand Alone	5.700K	CRI>80	4500 (500 Em.)	38W (+5W Emerg.)	105



Smart [3] Plus | 1600

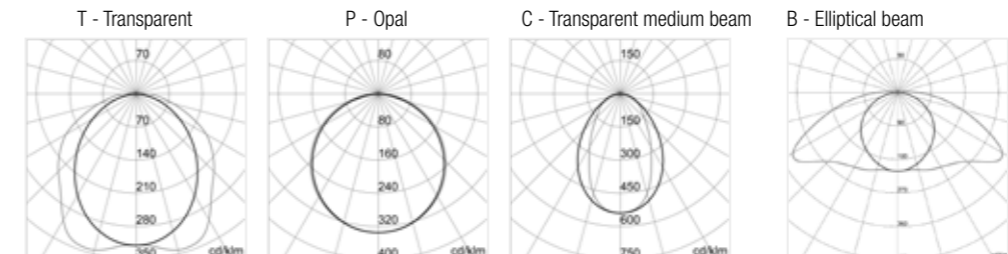

OPAL DIFFUSER

Code	Control system	Cabling	Colour temp. (CCT)	Colour rendering index (CRI)	Luminous flux of the device (lm)	Power consumption (W)	Efficiency (lm/W)
GWS3320AP830	On / Off	Stand Alone	3.000K	CRI>80	6800	46	148
GWS3320AP840	On / Off	Stand Alone	4.000K	CRI>80	7100	46	154
GWS3320AP857	On / Off	Stand Alone	5.700K	CRI>80	7100	46	154
GWS3320AP930	On / Off	Stand Alone	3.000K	CRI>90	5300	46	115
GWS3320AP940	On / Off	Stand Alone	4.000K	CRI>90	5600	46	122
GWS3320AP957	On / Off	Stand Alone	5.700K	CRI>90	5600	46	122
GWS3322AP830	On / Off	Through Wiring	3.000K	CRI>80	6800	46	148
GWS3322AP840	On / Off	Through Wiring	4.000K	CRI>80	7100	46	154
GWS3322AP857	On / Off	Through Wiring	5.700K	CRI>80	7100	46	154
GWS3322AP930	On / Off	Through Wiring	3.000K	CRI>90	5300	46	115
GWS3322AP940	On / Off	Through Wiring	4.000K	CRI>90	5600	46	122
GWS3322AP957	On / Off	Through Wiring	5.700K	CRI>90	5600	46	122
GWS3321AP830	DALI	Stand Alone	3.000K	CRI>80	6800	50	136
GWS3321AP840	DALI	Stand Alone	4.000K	CRI>80	7100	50	142
GWS3321AP857	DALI	Stand Alone	5.700K	CRI>80	7100	50	142
GWS3321AP930	DALI	Stand Alone	3.000K	CRI>90	5300	50	106
GWS3321AP940	DALI	Stand Alone	4.000K	CRI>90	5600	50	112
GWS3321AP957	DALI	Stand Alone	5.700K	CRI>90	5600	50	112
GWS3323AP830	DALI	Through Wiring	3.000K	CRI>80	6800	50	136
GWS3323AP840	DALI	Through Wiring	4.000K	CRI>80	7100	50	142
GWS3323AP857	DALI	Through Wiring	5.700K	CRI>80	7100	50	142
GWS3323AP930	DALI	Through Wiring	3.000K	CRI>90	5300	50	106
GWS3323AP940	DALI	Through Wiring	4.000K	CRI>90	5600	50	112
GWS3323AP957	DALI	Through Wiring	5.700K	CRI>90	5600	50	112

TRANSPARENT DIFFUSER

Code	Control system	Cabling	Colour temp. (CCT)	Colour rendering index (CRI)	Luminous flux of the device (lm)	Power consumption (W)	Efficiency (lm/W)
GWS3320AT830	On / Off	Stand Alone	3.000K	CRI>80	7100	46	154
GWS3320AT840	On / Off	Stand Alone	4.000K	CRI>80	7500	46	163
GWS3320AT857	On / Off	Stand Alone	5.700K	CRI>80	7500	46	163
GWS3320AT930	On / Off	Stand Alone	3.000K	CRI>90	5500	46	120
GWS3320AT940	On / Off	Stand Alone	4.000K	CRI>90	5900	46	128
GWS3320AT957	On / Off	Stand Alone	5.700K	CRI>90	5900	46	128
GWS3322AT830	On / Off	Through Wiring	3.000K	CRI>80	7100	46	154
GWS3322AT840	On / Off	Through Wiring	4.000K	CRI>80	7500	46	163
GWS3322AT857	On / Off	Through Wiring	5.700K	CRI>80	7500	46	163
GWS3322AT930	On / Off	Through Wiring	3.000K	CRI>90	5500	46	120
GWS3322AT940	On / Off	Through Wiring	4.000K	CRI>90	5900	46	128
GWS3322AT957	On / Off	Through Wiring	5.700K	CRI>90	5900	46	128
GWS3321AT830	DALI	Stand Alone	3.000K	CRI>80	7100	50	142
GWS3321AT840	DALI	Stand Alone	4.000K	CRI>80	7500	50	150
GWS3321AT857	DALI	Stand Alone	5.700K	CRI>80	7500	50	150
GWS3321AT930	DALI	Stand Alone	3.000K	CRI>90	5500	50	110
GWS3321AT940	DALI	Stand Alone	4.000K	CRI>90	5900	50	118
GWS3321AT957	DALI	Stand Alone	5.700K	CRI>90	5900	50	118
GWS3323AT830	DALI	Through Wiring	3.000K	CRI>80	7100	50	142
GWS3323AT840	DALI	Through Wiring	4.000K	CRI>80	7500	50	150
GWS3323AT857	DALI	Through Wiring	5.700K	CRI>80	7500	50	150
GWS3323AT930	DALI	Through Wiring	3.000K	CRI>90	5500	50	110
GWS3323AT940	DALI	Through Wiring	4.000K	CRI>90	5900	50	118
GWS3323AT957	DALI	Through Wiring	5.700K	CRI>90	5900	50	118

TRANSPARENT MEDIUM BEAM DIFFUSER

Code	Control system	Cabling	Colour temp. (CCT)	Colour rendering index (CRI)	Luminous flux of the device (lm)	Power consumption (W)	Efficiency (lm/W)
GWS3320AC830	On / Off	Stand Alone	3.000K	CRI>80	6700	46	146
GWS3320AC840	On / Off	Stand Alone	4.000K	CRI>80	7100	46	154
GWS3320AC857	On / Off	Stand Alone	5.700K	CRI>80	7100	46	154
GWS3320AC930	On / Off	Stand Alone	3.000K	CRI>90	5200	46	113
GWS3320AC940	On / Off	Stand Alone	4.000K	CRI>90	5600	46	122
GWS3320AC957	On / Off	Stand Alone	5.700K	CRI>90	5600	46	122
GWS3322AC830	On / Off	Through Wiring	3.000K	CRI>80	6700	46	146
GWS3322AC840	On / Off	Through Wiring	4.000K	CRI>80	7100	46	154
GWS3322AC857	On / Off	Through Wiring	5.700K	CRI>80	7100	46	154
GWS3322AC930	On / Off	Through Wiring	3.000K	CRI>90	5200	46	113
GWS3322AC940	On / Off	Through Wiring	4.000K	CRI>90	5600	46	122
GWS3322AC957	On / Off	Through Wiring	5.700K	CRI>90	5600	46	122
GWS3321AC830	DALI	Stand Alone	3.000K	CRI>80	6700	50	134
GWS3321AC840	DALI	Stand Alone	4.000K	CRI>80	7100	50	142
GWS3321AC857	DALI	Stand Alone	5.700K	CRI>80	7100	50	142
GWS3321AC930	DALI	Stand Alone	3.000K	CRI>90	5200	50	104
GWS3321AC940	DALI	Stand Alone	4.000K	CRI>90	5600	50	112
GWS3321AC957	DALI	Stand Alone	5.700K	CRI>90	5600	50	112
GWS3323AC830	DALI	Through Wiring	3.000K	CRI>80	6700	50	134
GWS3323AC840	DALI	Through Wiring	4.000K	CRI>80	7100	50	142
GWS3323AC857	DALI	Through Wiring	5.700K	CRI>80	7100	50	142
GWS3323AC930	DALI	Through Wiring	3.000K	CRI>90	5200	50	104
GWS3323AC940	DALI	Through Wiring	4.000K	CRI>90	5600	50	112
GWS3323AC957	DALI	Through Wiring	5.700K	CRI>90	5600	50	112

TRANSPARENT ELLIPTICAL BEAM DIFFUSER

Code	Control system	Cabling	Colour temp. (CCT)	Colour rendering index (CRI)	Luminous flux of the device (lm)	Power consumption (W)	Efficiency (lm/W)
GWS3320AB830	On / Off	Stand Alone	3.000K	CRI>80	6200	46	135
GWS3320AB840	On / Off	Stand Alone	4.000K	CRI>80	6600	46	143
GWS3320AB857	On / Off	Stand Alone	5.700K	CRI>80	6600	46	143
GWS3322AB830	On / Off	Through Wiring	3.000K	CRI>80	6200	46	135
GWS3322AB840	On / Off	Through Wiring	4.000K	CRI>80	6600	46	143
GWS3322AB857	On / Off	Through Wiring	5.700K	CRI>80	6600	46	143
GWS3321AB830	DALI	Stand Alone	3.000K	CRI>80	6200	50	124
GWS3321AB840	DALI	Stand Alone	4.000K	CRI>80	6600	50	132
GWS3321AB857	DALI	Stand Alone	5.700K	CRI>80	6600	50	132
GWS3323AB830	DALI	Through Wiring	3.000K	CRI>80	6200	50	124
GWS3323AB840	DALI	Through Wiring	4.000K	CRI>80	6600	50	132
GWS3323AB857	DALI	Through Wiring	5.700K	CRI>80	6600	50	132

DESIGN SOLUTION EXAMPLE:

Smart [3] Plus Transparent elliptical beam Covered Parking

REFERENCE STANDARD

UNI 12464-1:2011 - Covered public parking spaces	Illumination:	Uniformity 1:
par. 5.34.4: traffic lanes	E med ≥ 75lux	E min / E med ≥ 0,40



VALUES OBTAINED

UNI 12464-1:2011 - Covered public parking spaces	Illumination:	Uniformity 1:
par. 5.34.4: traffic lanes	E med = 84lux	E min / E med = 0,53

AREA DATA

Project area	Installation height:	Installation type:
1706m ²	2,5 m	ceiling

INSTALLED PRODUCTS

Code	Description	Quantity
GWS3320BB840	Smart [3] Plus - Ellittica HLO - STAND ALONE - 1600MM - LED CCT4000K CRI80 - CL 2	21

Smart [3] Plus | 1600 INTEGRATED EMERGENCY

OPAL DIFFUSER

Code	Control system	Cabling	Colour temp. (CCT)	Colour rendering index (CRI)	Luminous flux of the device (lm)	Power consumption (W)	Efficiency (lm/W)
GWS3325AP830	1 x DALI DT6 + 1 x DALI DT1 (Emerg. 3h)	Stand Alone	3.000K	CRI>80	6800 (560 Emerg.)	50 (+5 Emerg.)	115
GWS3325AP840	1 x DALI DT6 + 1 x DALI DT1 (Emerg. 3h)	Stand Alone	4.000K	CRI>80	7200 (600 Emerg.)	50 (+5 Emerg.)	120
GWS3325AP857	1 x DALI DT6 + 1 x DALI DT1 (Emerg. 3h)	Stand Alone	5.700K	CRI>80	7200 (600 Emerg.)	50 (+5 Emerg.)	120
GWS3325AP930	1 x DALI DT6 + 1 x DALI DT1 (Emerg. 3h)	Stand Alone	3.000K	CRI>80	5300 (440 Emerg.)	50 (+5 Emerg.)	89
GWS3325AP940	1 x DALI DT6 + 1 x DALI DT1 (Emerg. 3h)	Through Wiring	4.000K	CRI>80	5600 (460 Emerg.)	50 (+5 Emerg.)	95
GWS3325AP957	1 x DALI DT6 + 1 x DALI DT1 (Emerg. 3h)	Through Wiring	5.700K	CRI>80	5600 (460 Emerg.)	50 (+5 Emerg.)	95

TRANSPARENT DIFFUSER

Code	Control system	Cabling	Colour temp. (CCT)	Colour rendering index (CRI)	Luminous flux of the device (lm)	Power consumption (W)	Efficiency (lm/W)
GWS3325AT830	1 x DALI DT6 + 1 x DALI DT1 (Emerg. 3h)	Stand Alone	3.000K	CRI>80	7100 (600 Emerg.)	50 (+5 Emerg.)	129
GWS3325AT840	1 x DALI DT6 + 1 x DALI DT1 (Emerg. 3h)	Stand Alone	4.000K	CRI>80	7500 (630 Emerg.)	50 (+5 Emerg.)	136
GWS3325AT857	1 x DALI DT6 + 1 x DALI DT1 (Emerg. 3h)	Stand Alone	5.700K	CRI>80	7500 (630 Emerg.)	50 (+5 Emerg.)	136
GWS3325AT930	1 x DALI DT6 + 1 x DALI DT1 (Emerg. 3h)	Stand Alone	3.000K	CRI>80	5500 (460 Emerg.)	50 (+5 Emerg.)	100
GWS3325AT940	1 x DALI DT6 + 1 x DALI DT1 (Emerg. 3h)	Through Wiring	4.000K	CRI>80	5900 (500 Emerg.)	50 (+5 Emerg.)	107
GWS3325AT957	1 x DALI DT6 + 1 x DALI DT1 (Emerg. 3h)	Through Wiring	5.700K	CRI>80	5900 (500 Emerg.)	50 (+5 Emerg.)	107

OPAL ELLIPTICAL BEAM DIFFUSER

Code	Control system	Cabling	Colour temp. (CCT)	Colour rendering index (CRI)	Luminous flux of the device (lm)	Power consumption (W)	Efficiency (lm/W)
GWS3325AB840	1 x DALI DT6 + 1 x DALI DT1 (Emerg. 3h)	Stand Alone	4.000K	CRI>80	6600(550 Emerg.)	50 (+5 Emerg.)	120
GWS3325AB857	1 x DALI DT6 + 1 x DALI DT1 (Emerg. 3h)	Stand Alone	5.700K	CRI>80	6600(550 Emerg.)	50 (+5 Emerg.)	120



Smart [3] Plus | 1600 HLO

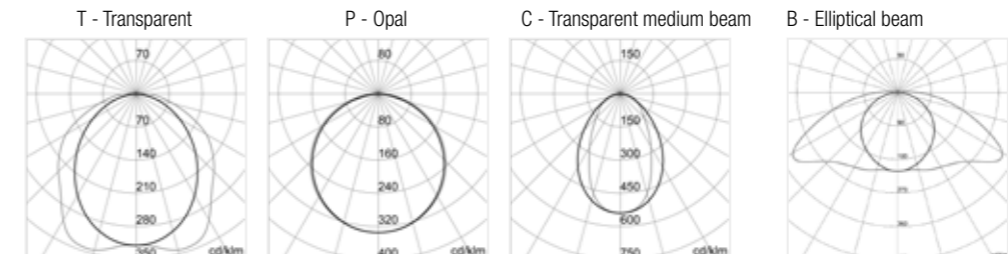

OPAL DIFFUSER

Code	Control system	Cabling	Colour temp. (CCT)	Colour rendering index (CRI)	Luminous flux of the device (lm)	Power consumption (W)	Efficiency (lm/W)
GWS3320BP830	On/Off	Stand Alone	3,000K	CRI>80	8500	61	139
GWS3320BP840	On/Off	Stand Alone	4,000K	CRI>80	9000	61	148
GWS3320BP857	On/Off	Stand Alone	5,700K	CRI>80	9000	61	148
GWS3320BP930	On/Off	Stand Alone	3,000K	CRI>90	6600	61	108
GWS3320BP940	On/Off	Stand Alone	4,000K	CRI>90	7100	61	116
GWS3320BP957	On/Off	Stand Alone	5,700K	CRI>90	7100	61	116
GWS3322BP830	On/Off	Through Wiring	3,000K	CRI>80	8500	61	139
GWS3322BP840	On/Off	Through Wiring	4,000K	CRI>80	9000	61	148
GWS3322BP857	On/Off	Through Wiring	5,700K	CRI>80	9000	61	148
GWS3322BP930	On/Off	Through Wiring	3,000K	CRI>90	6600	61	108
GWS3322BP940	On/Off	Through Wiring	4,000K	CRI>90	7100	61	116
GWS3322BP957	On/Off	Through Wiring	5,700K	CRI>90	7100	61	116
GWS3321BP830	DALI	Stand Alone	3,000K	CRI>80	8500	63	135
GWS3321BP840	DALI	Stand Alone	4,000K	CRI>80	9000	63	143
GWS3321BP857	DALI	Stand Alone	5,700K	CRI>80	9000	63	143
GWS3321BP930	DALI	Stand Alone	3,000K	CRI>90	6600	63	105
GWS3321BP940	DALI	Stand Alone	4,000K	CRI>90	7100	63	113
GWS3321BP957	DALI	Stand Alone	5,700K	CRI>90	7100	63	113
GWS3323BP830	DALI	Through Wiring	3,000K	CRI>80	8500	63	135
GWS3323BP840	DALI	Through Wiring	4,000K	CRI>80	9000	63	143
GWS3323BP857	DALI	Through Wiring	5,700K	CRI>80	9000	63	143
GWS3323BP930	DALI	Through Wiring	3,000K	CRI>90	6600	63	105
GWS3323BP940	DALI	Through Wiring	4,000K	CRI>90	7100	63	113
GWS3323BP957	DALI	Through Wiring	5,700K	CRI>90	7100	63	113

TRANSPARENT DIFFUSER

Code	Control system	Cabling	Colour temp. (CCT)	Colour rendering index (CRI)	Luminous flux of the device (lm)	Power consumption (W)	Efficiency (lm/W)
GWS3320BT830	On/Off	Stand Alone	3,000K	CRI>80	8900	61	146
GWS3320BT840	On/Off	Stand Alone	4,000K	CRI>80	9400	61	154
GWS3320BT857	On/Off	Stand Alone	5,700K	CRI>80	9400	61	154
GWS3320BT930	On/Off	Stand Alone	3,000K	CRI>90	6900	61	113
GWS3320BT940	On/Off	Stand Alone	4,000K	CRI>90	7400	61	121
GWS3320BT957	On/Off	Stand Alone	5,700K	CRI>90	7400	61	121
GWS3322BT830	On/Off	Through Wiring	3,000K	CRI>80	8900	61	146
GWS3322BT840	On/Off	Through Wiring	4,000K	CRI>80	9400	61	154
GWS3322BT857	On/Off	Through Wiring	5,700K	CRI>80	9400	61	154
GWS3322BT930	On/Off	Through Wiring	3,000K	CRI>90	6900	61	113
GWS3322BT940	On/Off	Through Wiring	4,000K	CRI>90	7400	61	121
GWS3322BT957	On/Off	Through Wiring	5,700K	CRI>90	7400	61	121
GWS3321BT830	DALI	Stand Alone	3,000K	CRI>80	8900	63	141
GWS3321BT840	DALI	Stand Alone	4,000K	CRI>80	9400	63	149
GWS3321BT857	DALI	Stand Alone	5,700K	CRI>80	9400	63	149
GWS3321BT930	DALI	Stand Alone	3,000K	CRI>90	6900	63	110
GWS3321BT940	DALI	Stand Alone	4,000K	CRI>90	7400	63	117
GWS3321BT957	DALI	Stand Alone	5,700K	CRI>90	7400	63	117
GWS3323BT830	DALI	Through Wiring	3,000K	CRI>80	8900	63	141
GWS3323BT840	DALI	Through Wiring	4,000K	CRI>80	9400	63	149
GWS3323BT857	DALI	Through Wiring	5,700K	CRI>80	9400	63	149
GWS3323BT930	DALI	Through Wiring	3,000K	CRI>90	6900	63	110
GWS3323BT940	DALI	Through Wiring	4,000K	CRI>90	7400	63	117
GWS3323BT957	DALI	Through Wiring	5,700K	CRI>90	7400	63	117

Smart [3] Plus | 1600 HLO INTEGRATED EMERGENCY

TRANSPARENT DIFFUSER MEDIUM BEAM

Code	Control system	Cabling	Colour temp. (CCT)	Colour rendering index (CRI)	Luminous flux of the device (lm)	Power consumption (W)	Efficiency (lm/W)
GWS3320BC830	On/Off	Stand Alone	3,000K	CRI>80	8500	61	139
GWS3320BC840	On/Off	Stand Alone	4,000K	CRI>80	8900	61	146
GWS3320BC857	On/Off	Stand Alone	5,700K	CRI>80	8900	61	146
GWS3320BC930	On/Off	Stand Alone	3,000K	CRI>90	6600	61	108
GWS3320BC940	On/Off	Stand Alone	4,000K	CRI>90	7100	61	116
GWS3320BC957	On/Off	Stand Alone	5,700K	CRI>90	7100	61	116
GWS3322BC830	On/Off	Through Wiring	3,000K	CRI>80	8500	61	139
GWS3322BC840	On/Off	Through Wiring	4,000K	CRI>80	8900	61	146
GWS3322BC857	On/Off	Through Wiring	5,700K	CRI>80	8900	61	146
GWS3322BC930	On/Off	Through Wiring	3,000K	CRI>90	6600	61	108
GWS3322BC940	On/Off	Through Wiring	4,000K	CRI>90	7100	61	116
GWS3322BC957	On/Off	Through Wiring	5,700K	CRI>90	7100	61	116
GWS3321BC830	DALI	Stand Alone	3,000K	CRI>80	8500	63	135
GWS3321BC840	DALI	Stand Alone	4,000K	CRI>80	8900	63	141
GWS3321BC857	DALI	Stand Alone	5,700K	CRI>80	8900	63	141
GWS3321BC930	DALI	Stand Alone	3,000K	CRI>90	6600	63	105
GWS3321BC940	DALI	Stand Alone	4,000K	CRI>90	7100	63	113
GWS3321BC957	DALI	Stand Alone	5,700K	CRI>90	7100	63	113
GWS3323BC830	DALI	Through Wiring	3,000K	CRI>80	8500	63	135
GWS3323BC840	DALI	Through Wiring	4,000K	CRI>80	8900	63	141
GWS3323BC857	DALI	Through Wiring	5,700K	CRI>80	8900	63	141
GWS3323BC930	DALI	Through Wiring	3,000K	CRI>90	6600	63	105
GWS3323BC940	DALI	Through Wiring	4,000K	CRI>90	7100	63	113
GWS3323BC957	DALI	Through Wiring	5,700K	CRI>90	7100	63	113

TRANSPARENT ELLIPTICAL BEAM DIFFUSER

Code	Control system	Cabling	Colour temp. (CCT)	Colour rendering index (CRI)	Luminous flux of the device (lm)	Power consumption (W)	Efficiency (lm/W)
GWS3320BB830	On / Off	Stand Alone	3,000K	CRI>80	7800	61	128
GWS3320BB840	On / Off	Stand Alone	4,000K	CRI>80	8200	61	134
GWS3320BB857	On / Off	Stand Alone	5,700K	CRI>80	8200	61	134
GWS3322BB830	On / Off	Through Wiring	3,000K	CRI>80	7800	61	128
GWS3322BB840	On / Off	Through Wiring	4,000K	CRI>80	8200	61	134
GWS3322BB857	On / Off	Through Wiring	5,700K	CRI>80	8200	61	134
GWS3321BB830	DALI	Stand Alone	3,000K	CRI>80	7800	63	124
GWS3321BB840	DALI	Stand Alone	4,000K	CRI>80	8200	63	130
GWS3321BB857	DALI	Stand Alone	5,700K	CRI>80	8200	63	130
GWS3323BB830	DALI	Through Wiring	3,000K	CRI>80	7800	63	124
GWS3323BB840	DALI	Through Wiring	4,000K	CRI>80	8200	63	130
GWS3323BB857	DALI	Through Wiring	5,700K	CRI>80	8200	63	130

TRANSPARENT DIFFUSER

Code	Control system	Cabling	Colour temp. (CCT)	Colour rendering index (CRI)	Luminous flux of the device (lm)	Power consumption (W)	Efficiency (lm/W)
GWS3325BT830	1 x DALI DT6 + 1 x DALI DT1 (Emerg. 3h)	Stand Alone	3,000K	CRI>80	8900 (600 Emerg.)	63 (+5 Emerg.)	131
GWS3325BT840	1 x DALI DT6 + 1 x DALI DT1 (Emerg. 3h)	Stand Alone	4,000K	CRI>80	9400 (630 Emerg.)	63 (+5 Emerg.)	138
GWS3325BT857	1 x DALI DT6 + 1 x DALI DT1 (Emerg. 3h)	Stand Alone	5,700K	CRI>80	9400 (630 Emerg.)	63 (+5 Emerg.)	138
GWS3325BT930	1 x DALI DT6 + 1 x DALI DT1 (Emerg. 3h)	Stand Alone	3,000K	CRI>80	6900 (460 Emerg.)	63 (+5 Emerg.)	101
GWS3325BT940	1 x DALI DT6 + 1 x DALI DT1 (Emerg. 3h)	Through Wiring	4,000K	CRI>80	7400 (500 Emerg.)	63 (+5 Emerg.)	109
GWS3325BT957	1 x DALI DT6 + 1 x DALI DT1 (Emerg. 3h)	Through Wiring	5,700K	CRI>80	7400 (500 Emerg.)	63 (+5 Emerg.)	109

OPAL DIFFUSER

Code	Control system	Cabling	Colour temp. (CCT)	Colour rendering index (CRI)	Luminous flux of the device (lm)	Power consumption (W)	Efficiency (lm/W)
GWS3325BP830	1 x DALI DT6 + 1 x DALI DT1 (Emerg. 3h)	Stand Alone	3,000K	CRI>80	8500 (560 Emerg.)	63 (+5 Emerg.)	116
GWS3325BP840	1 x DALI DT6 + 1 x DALI DT1 (Emerg. 3h)	Stand Alone	4,000K	CRI>80	9000 (600 Emerg.)	63 (+5 Emerg.)	122
GWS3325BP857	1 x DALI DT6 + 1 x DALI DT1 (Emerg. 3h)	Stand Alone	5,700K	CRI>80	9000 (600 Emerg.)	63 (+5 Emerg.)	122
GWS3325BP930	1 x DALI DT6 + 1 x DALI DT1 (Emerg. 3h)	Stand Alone	3,000K	CRI>80	6600 (440 Emerg.)	63 (+5 Emerg.)	90
GWS3325BP940	1 x DALI DT6 + 1 x DALI DT1 (Emerg. 3h)	Through Wiring	4,000K	CRI>80	7200 (460 Emerg.)	63 (+5 Emerg.)	97
GWS3325BP957	1 x DALI DT6 + 1 x DALI DT1 (Emerg. 3h)	Through Wiring	5,700K	CRI>80	7200 (460 Emerg.)	63 (+5 Emerg.)	97

TRANSPARENT ELLIPTICAL BEAM DIFFUSER

Code	Control system	Cabling	Colour temp. (CCT)	Colour rendering index (CRI)	Luminous flux of the device (lm)	Power consumption (W)	Efficiency (lm/W)
GWS3325BB840	1 x DALI DT6 + 1 x DALI DT1 (Emerg. 3h)	Through Wiring	4,000K	CRI>80	8200(550 Emerg.)	63 (+5 Emerg.)	121
GWS3325BB857	1 x DALI DT6 + 1 x DALI DT1 (Emerg. 3h)	Through Wiring	5,700K	CRI>80	8200(550 Emerg.)	63 (+5 Emerg.)	121

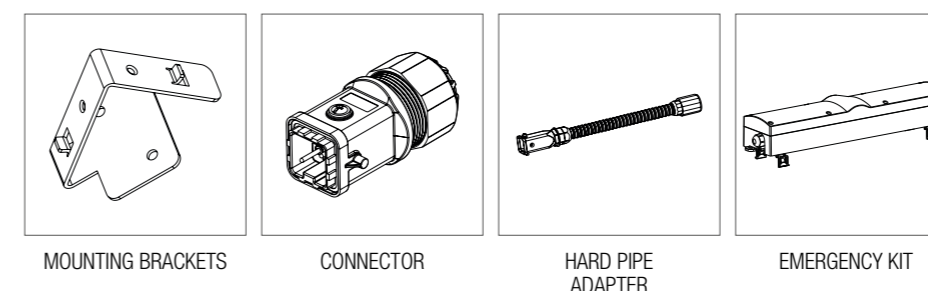

SMART PLUS [3] ACCESSORIES

Code	Description
GWS3191	Pair of brackets for 30° and 45° wall mounting
GWS3192	2P 10A male connector
GWS3193	Hard pipe adapter Ø 20mm
GWS3198	Emergency kit 3 h Smart [3] Through Wiring

DESIGN SOLUTION EXAMPLE:

Smart [3] Plus HLO Transparent medium beam Industrial - Storage Area

REFERENCE STANDARD

UNI 12464-1:2011 - Warehouses and Warehouses with shelves	Illumination:	Uniformity:
par. 5.4.1: warehouses, storage areas (continuously occupied)	E med $\geq 200\text{lux}$	E min / E med $\geq 0,40$
5.4.2: Handling Zones, Packaging, Shipping	E med $\geq 300\text{lux}$	E min/E med ≥ 0.60
par. 5.5.2: warehouses with shelves - corridors with staff	E med $\geq 150\text{lux}$	E min / E med $\geq 0,40$



VALUES OBTAINED

UNI 12464-1:2011 - Warehouses and Warehouses with shelves	Illumination:	Uniformity:
par. 5.4.1: warehouses, storage areas (continuously occupied)	E med $\geq 208\text{lux}$	E min / E med $\geq 0,69$
5.4.1: Handling Zones, Packaging, Shipping	E med $\geq 302\text{lux}$	E min / E med $\geq 0,61$
par. 5.5.2: warehouses with shelves - corridors with staff	E med $\geq 152\text{lux}$	E min / E med $\geq 0,89$

AREA DATA

Project area	Installation height:	Installation type:
4802 m ²	8.5 m	on light

INSTALLED PRODUCTS

Code	Description	Quantity
GWS3320BC840	Smart [3] Plus HLO with Medium -Beam lens - 1600MM - LED CCT4000K CRI80 - CL 2 - HLO	186



Smart [3] Plus and Smart [3]



Smart [3]

Watertight LED ceiling light with energy savings and high impact resistance.

Smart [3] is a LED watertight ceiling light for industrial applications, ideal for production areas, indoor parking spaces. The ceiling light can be installed on ceilings using spring clips with adjustable quick fix coupling, which allow for a wide range of axes, so you can use existing fixing points. The fitting can be suspended or wall mounted. For wall installation, the Gw bracket accessory is also available so this watertight appliance can be orientated on a vertical axis, at a 30° and 45° angle. The Through-Wiring version is already equipped with pre-wired mechanical and electrical connection components. The maximum number of fittings that can be installed in a continuous row is 25. Polycarbonate construction, in grey RAL7035. Available in 3 sizes and powers, with integrated power in the On/Off or DALI versions. Two different optics, thanks to the Transparent and Opal diffuser. The LED lights can replace all versions of linear fluorescent lights from 18W to 58W, both in single-lamp and dual-lamp versions, and can be installed up to 4 metres.

- 
- IP 66**
- IP 69**
- IK 08**
- 
- GWT 850°C**
- 
- 
- 

APPLICATIONS

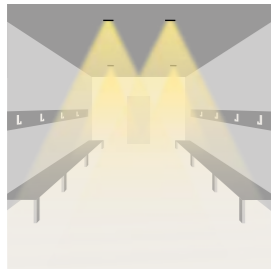

Changing rooms

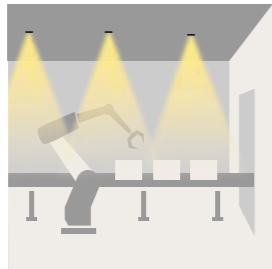

Production Lines

LIGHT BEAM DISTRIBUTION

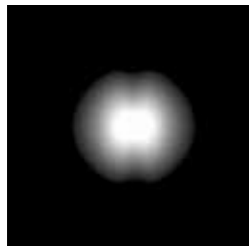

T - Transparent



P - Opal





SIZE

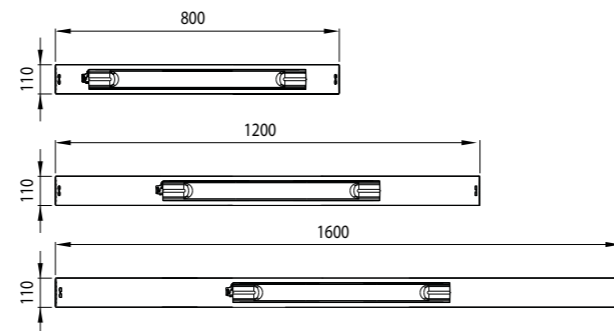

GENERAL INFORMATION

Recommended installation height	Less than 4 m
Relamping	The LED lights can replace all versions of linear fluorescent watertight lights from 18W to 58W, both in single-lamp and dual-lamp versions.
Body	Self-extinguishing polycarbonate coloured in grey RAL7035
Diffuser	UV-stabilised self-extinguishing polycarbonate with excellent transmittance in opal or transparent finish
Sealing	The coupling between the unit and the diffuser is made with two-component polyurethane sealant to ensure a stable seal over time
LED technology	EPI UP with wire bonding
LED internal reflector	PCT plastic with silver metallization
Electrical connection	The electrical connector is equipped with a quick, ergonomic connection system for cables with up to 1.5 mm ² section and a side safety lever-driven device.
Installation	The ceiling light can be installed on the ceiling using spring clips with adjustable quick fix coupling, which allows for a wide range of axes, thus allowing the reuse of existing fixing points. The device can be hung or wall mounted. For wall installation, the GEWISS Bracket accessory is also available, which allows the watertight appliance to be orientated on the vertical axis, at a 30° and 45° angle. The Through Wiring version is already equipped with pre-wired mechanical and electrical connection components. The maximum number of devices installed in a continuous row is 25.
Emergency	The Smart [3] range is available in an emergency version. The Emergency function comes in three different modes: <ul style="list-style-type: none"> • under UPS with the latest driver; • with an external emergency kit that can be purchased as an accessory, only for the Through Wiring versions.

PHOTOMETRY

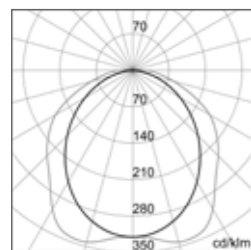

T - Transparent

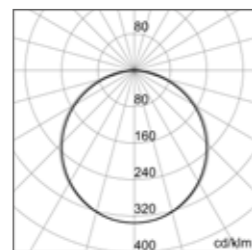

P - Opal



Smart [3] | 800

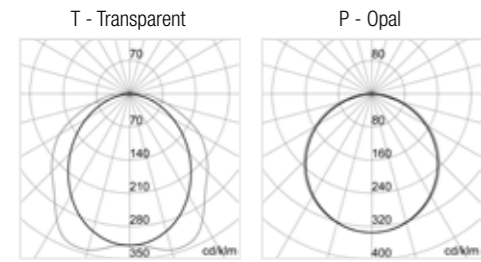

OPAL DIFFUSER

Code	Control system	Cabling	Colour temp. (CCT)	Colour rendering index (CRI)	Luminous flux of the device (lm)	Power consumption (W)	Efficiency (lm/W)
GWS3118P	On/Off	Stand Alone	4,000K	CRI>80	1600	15	107
GWS3218P	On/Off	Stand Alone	4,000K	CRI>80	3200	27	119
GWS3218P30K	On/Off	Stand Alone	3,000K	CRI>80	3000	27	111
GWS3218P57K	On/Off	Stand Alone	5,700K	CRI>80	3200	27	119
GWS3118PL	On/Off	Through Wiring	4,000K	CRI>80	1600	15	107
GWS3218PL	On/Off	Through Wiring	4,000K	CRI>80	3200	27	119
GWS3218PL30K	On/Off	Through Wiring	3,000K	CRI>80	3000	27	111
GWS3218PL57K	On/Off	Through Wiring	5,700K	CRI>80	3200	27	119
GWS3118PD	DALI	Stand Alone	4,000K	CRI>80	1600	15	107
GWS3218PD	DALI	Stand Alone	4,000K	CRI>80	3200	27	119
GWS3218PD30K	DALI	Stand Alone	3,000K	CRI>80	3000	27	111
GWS3218PD57K	DALI	Stand Alone	5,700K	CRI>80	3200	27	119
GWS3118PLD	DALI	Through Wiring	4,000K	CRI>80	1600	15	107
GWS3218PLD	DALI	Through Wiring	4,000K	CRI>80	3200	27	119
GWS3218PLD30K	DALI	Through Wiring	3,000K	CRI>80	3000	27	111
GWS3218PLD57K	DALI	Through Wiring	5,700K	CRI>80	3200	27	119

TRANSPARENT DIFFUSER

Code	Control system	Cabling	Colour temp. (CCT)	Colour rendering index (CRI)	Luminous flux of the device (lm)	Power consumption (W)	Efficiency (lm/W)
GWS3118T	On/Off	Stand Alone	4,000K	CRI>80	1700	15	113
GWS3218T	On/Off	Stand Alone	4,000K	CRI>80	3400	27	126
GWS3218T30K	On/Off	Stand Alone	3,000K	CRI>80	3200	27	119
GWS3218T57K	On/Off	Stand Alone	5,700K	CRI>80	3400	27	126
GWS3118TL	On/Off	Through Wiring	4,000K	CRI>80	1700	15	113
GWS3218TL	On/Off	Through Wiring	4,000K	CRI>80	3400	27	126
GWS3218TL30K	On/Off	Through Wiring	3,000K	CRI>80	3200	27	119
GWS3218TL57K	On/Off	Through Wiring	5,700K	CRI>80	3400	27	126
GWS3118TD	DALI	Stand Alone	4,000K	CRI>80	1700	15	113
GWS3218TD	DALI	Stand Alone	4,000K	CRI>80	3400	27	126
GWS3218TD30K	DALI	Stand Alone	3,000K	CRI>80	3200	27	119
GWS3218TD57K	DALI	Stand Alone	5,700K	CRI>80	3400	27	126
GWS3118TLD	DALI	Through Wiring	4,000K	CRI>80	1700	15	113
GWS3218TLD	DALI	Through Wiring	4,000K	CRI>80	3400	27	126
GWS3218TLD30K	DALI	Through Wiring	3,000K	CRI>80	3200	27	119
GWS3218TLD57K	DALI	Through Wiring	5,700K	CRI>80	3400	27	126

Smart [3] | 1200

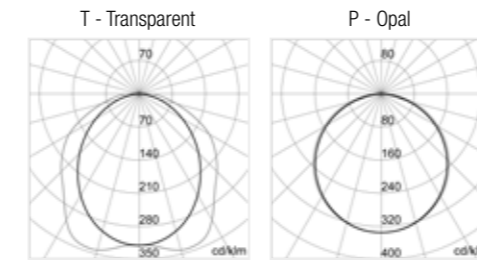

OPAL DIFFUSER

Code	Control system	Cabling	Colour temp. (CCT)	Colour rendering index (CRI)	Luminous flux of the device (lm)	Power consumption (W)	Efficiency (lm/W)
GWS3136P	On/Off	Stand Alone	4,000K	CRI>80	2500	20	125
GWS3236P	On/Off	Stand Alone	4,000K	CRI>80	5000	40	125
GWS3236P30K	On/Off	Stand Alone	3,000K	CRI>80	4800	40	120
GWS3236P57K	On/Off	Stand Alone	5,700K	CRI>80	5000	40	125
GWS3136PL	On/Off	Through Wiring	4,000K	CRI>80	2500	20	125
GWS3236PL	On/Off	Through Wiring	4,000K	CRI>80	5000	40	125
GWS3236PL30K	On/Off	Through Wiring	3,000K	CRI>80	4800	40	120
GWS3236PL57K	On/Off	Through Wiring	5,700K	CRI>80	5000	40	125
GWS3136PD	DALI	Stand Alone	4,000K	CRI>80	2500	20	125
GWS3236PD	DALI	Stand Alone	4,000K	CRI>80	5000	40	125
GWS3236PD30K	DALI	Stand Alone	3,000K	CRI>80	4800	40	120
GWS3236PD57K	DALI	Stand Alone	5,700K	CRI>80	5000	40	125
GWS3136PLD	DALI	Through Wiring	4,000K	CRI>80	2500	20	125
GWS3236PLD	DALI	Through Wiring	4,000K	CRI>80	5000	40	125
GWS3236PLD30K	DALI	Through Wiring	3,000K	CRI>80	4800	40	120
GWS3236PLD57K	DALI	Through Wiring	5,700K	CRI>80	5000	40	125

TRANSPARENT DIFFUSER

Code	Control system	Cabling	Colour temp. (CCT)	Colour rendering index (CRI)	Luminous flux of the device (lm)	Power consumption (W)	Efficiency (lm/W)
GWS3136T	On/Off	Stand Alone	4,000K	CRI>80	2600	20	130
GWS3236T	On/Off	Stand Alone	4,000K	CRI>80	5200	40	123
GWS3236T30K	On/Off	Stand Alone	3,000K	CRI>80	4900	40	115
GWS3236T57K	On/Off	Stand Alone	5,700K	CRI>80	5200	40	123
GWS3136TL	On/Off	Through Wiring	4,000K	CRI>80	2600	20	125
GWS3236TL	On/Off	Through Wiring	4,000K	CRI>80	5200	40	123
GWS3236TL30K	On/Off	Through Wiring	3,000K	CRI>80	4900	40	115
GWS3236TL57K	On/Off	Through Wiring	5,700K	CRI>80	5200	40	123
GWS3136TD	DALI	Stand Alone	4,000K	CRI>80	2600	20	125
GWS3236TD	DALI	Stand Alone	4,000K	CRI>80	5200	40	123
GWS3236TD30K	DALI	Stand Alone	3,000K	CRI>80	4900	40	115
GWS3236TD57K	DALI	Stand Alone	5,700K	CRI>80	5200	40	123
GWS3136TLD	DALI	Through Wiring	4,000K	CRI>80	2600	20	125
GWS3236TLD	DALI	Through Wiring	4,000K	CRI>80	5200	40	123
GWS3236TLD30K	DALI	Through Wiring	3,000K	CRI>80	4900	40	115
GWS3236TLD57K	DALI	Through Wiring	5,700K	CRI>80	5200	40	123

Smart [3] | 1600

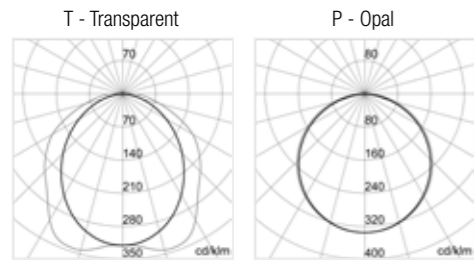

OPAL DIFFUSER

Code	Control system	Cabling	Colour temp. (CCT)	Colour rendering index (CRI)	Luminous flux of the device (lm)	Power consumption (W)	Efficiency (lm/W)
GWS3158P	On/Off	Stand Alone	4,000K	CRI>80	3250	26	125
GWS3258P	On/Off	Stand Alone	4,000K	CRI>80	6400	50	128
GWS3258P30K	On/Off	Stand Alone	3,000K	CRI>80	6100	50	122
GWS3258P57K	On/Off	Stand Alone	5,700K	CRI>80	6400	50	128
GWS3158PL	On/Off	Through Wiring	4,000K	CRI>80	3250	26	125
GWS3258PL	On/Off	Through Wiring	4,000K	CRI>80	6400	50	128
GWS3258PL30K	On/Off	Through Wiring	3,000K	CRI>80	6100	50	122
GWS3258PL57K	On/Off	Through Wiring	5,700K	CRI>80	6400	50	128
GWS3158PD	DALI	Stand Alone	4,000K	CRI>80	3250	26	125
GWS3258PD	DALI	Stand Alone	4,000K	CRI>80	6400	50	128
GWS3258PD30K	DALI	Stand Alone	3,000K	CRI>80	6100	50	122
GWS3258PD57K	DALI	Stand Alone	5,700K	CRI>80	6400	50	128
GWS3158PLD	DALI	Through Wiring	4,000K	CRI>80	3250	26	125
GWS3258PLD	DALI	Through Wiring	4,000K	CRI>80	6400	50	128
GWS3258PLD30K	DALI	Through Wiring	3,000K	CRI>80	6100	50	122
GWS3258PLD57K	DALI	Through Wiring	5,700K	CRI>80	6400	50	128

TRANSPARENT DIFFUSER

Code	Control system	Cabling	Colour temp. (CCT)	Colour rendering index (CRI)	Luminous flux of the device (lm)	Power consumption (W)	Efficiency (lm/W)
GWS3158T	On/Off	Stand Alone	4,000K	CRI>80	3400	26	131
GWS3258T	On/Off	Stand Alone	4,000K	CRI>80	6700	50	134
GWS3258T30K	On/Off	Stand Alone	3,000K	CRI>80	6400	50	128
GWS3258T57K	On/Off	Stand Alone	5,700K	CRI>80	6700	50	134
GWS3158TL	On/Off	Through Wiring	4,000K	CRI>80	3400	26	131
GWS3258TL	On/Off	Through Wiring	4,000K	CRI>80	6700	50	134
GWS3258TL30K	On/Off	Through Wiring	3,000K	CRI>80	6400	50	128
GWS3258TL57K	On/Off	Through Wiring	5,700K	CRI>80	6700	50	134
GWS3158TD	DALI	Stand Alone	4,000K	CRI>80	3400	26	131
GWS3258TD	DALI	Stand Alone	4,000K	CRI>80	6700	50	134
GWS3258TD30K	DALI	Stand Alone	3,000K	CRI>80	6400	50	128
GWS3258TD57K	DALI	Stand Alone	5,700K	CRI>80	6700	50	134
GWS3158TLD	DALI	Through Wiring	4,000K	CRI>80	3400	26	131
GWS3258TLD	DALI	Through Wiring	4,000K	CRI>80	6700	50	134
GWS3258TLD30K	DALI	Through Wiring	3,000K	CRI>80	6400	50	128
GWS3258TLD57K	DALI	Through Wiring	5,700K	CRI>80	6700	50	134

SMART [3] ACCESSORIES

Code	Description
GWS3191	Pair of brackets for 30° and 45° wall mounting
GWS3192	2P 10A male connector
GWS3193	Hard pipe adapter Ø 20mm
GWS3198	Emergency kit 3 h Smart [3] Through wiring

DESIGN SOLUTION EXAMPLE:

Smart [3] Transparent Industrial - Manufacturing areas

REFERENCE STANDARD

UNI 12464-1:2011 Metal Processing and Transformation	Illumination:	Uniformity:
par.5.18.11 Assembly (rough)	E med ≥ 200lux	E min / E med ≥ 0,60
par.5.18.11 Assembly (medium)	E med ≥ 300lux	E min / E med ≥ 0,60



VALUES OBTAINED

UNI 12464-1:2011 - Covered public parking spaces	Illumination:	Uniformity:
par.5.18.11 Assembly (rough)	E med = 220	E min / E med = 0,69
par.5.18.11 Assembly (medium)	E med = 325	E min / E med = 0,61

AREA DATA

Project area	Installation height:	Installation type:
2778m ²	4m	on bus duct light

INSTALLED PRODUCTS

Code	Description	Quantity
GWS3258T	Smart [3] Plus - Transparent - STAND ALONE - 1600MM - LED CCT4000K CRI80 - CL 2	65

Installation method

Ceiling mounted



Ceiling



Suspension

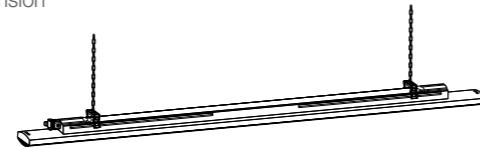

Bus duct



Ranging rod



Installation benefits

Special application use

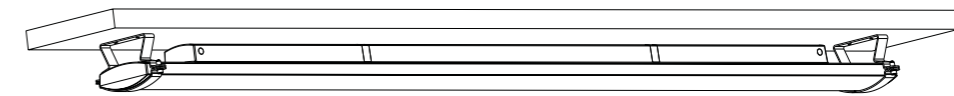
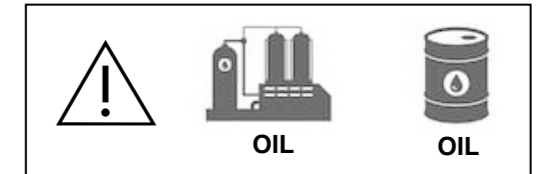
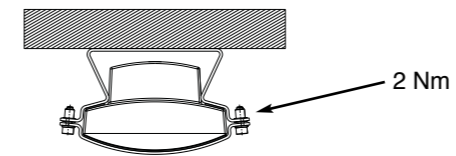

Wall-mounted



30° Bracket

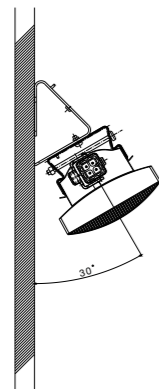

45° Bracket

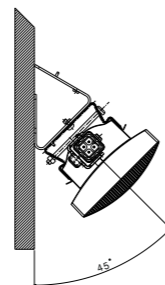

Quick wiring connector

Description	Smart [3] connector feature
IP Grade protection	Smart [3] IP Grades
Colour	Grey RAL7035
Flexible cable section (mm ²)	0.5 (tinned cable only) - 2.5 mm ²
Hard cable section (mm ²)	0.5 - 2.5 mm ²
CPI or CPPI (with or without breaking capacity)	CPPI
In (A)	16 A
Vn (V)	230 - 400 V
Impulse endurance (Kv)	4 kV
Pollution level	3
Torque tightening ring nut case (Nm)	4 Nm
Cable sheathing (mm)	40 mm
Wire stripping (mm)	6 mm
Cable diameter range (mm)	7 - 14.4 mm
DALI	Through Wiring
DALI	Through Wiring

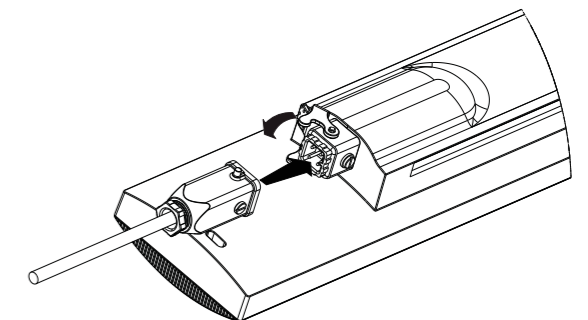



SOFTWARE



BIM is an online software that can be used on any internet-connected device (smartphone, tablet, or PC) with which you can download BIM models of GEWISS products.



Plugin for professional light design with GEWISS products, for use with Relux® software.

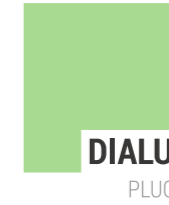

Plugin for professional light design with GEWISS products, for use with Dialux® software.



Plugin for the realisation of BIM projects with GEWISS products, for use with Revit® software.

GEWISS AT YOUR SERVICE

WWW.GEWISS.COM



Our website is constantly evolving to ensure you always have up-to-date information and useful work tools, which can be downloaded or consulted online at any time. In this section, you can also build your own custom catalogue and save your favourite products and services, so you can save time when viewing them, or simply keep them as an archive for your projects.

DOCUMENTATION

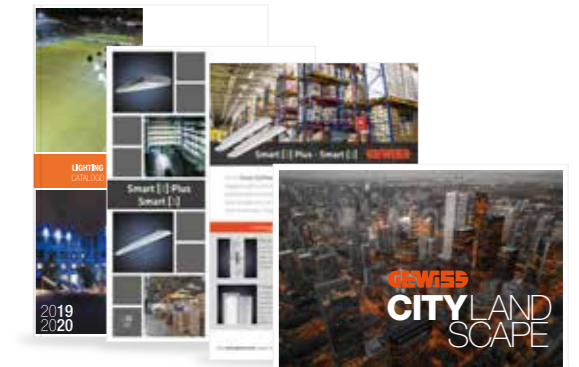

GEWISS develops different types of documentation for each product and solution range, from technical data sheets and specifications, to flyers, family or service brochures, to Solution catalogues dedicated to the various application segments, with insights into integrated solutions and IoT. Request the documentation you need from your trusted business contact or visit gewiss.com

DESIGN TEAM

Supporting you in the design of your electrical or lighting system, GEWISS provides specialised designers who can clarify your concerns or collaborate with you in drafting the design, ensuring quality and professionalism.

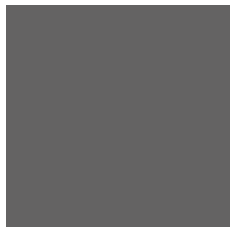
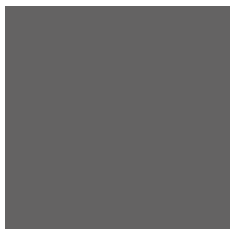
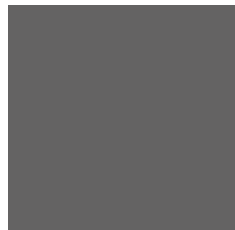

GEWISS

Visit www.gewiss.com and follow us on:

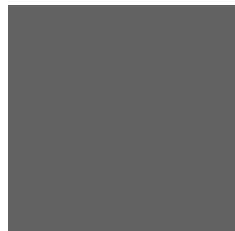

GEWISS S.p.A.

Registered Office: Via A. Volta, 1
24069 CENATE SOTTO BG - Italy
Tel. +39 035 946 111 - Fax. +39 035 945 222
gewiss@gewiss.com - www.gewiss.com

Single shareholder company - Bergamo Business Register/VAT/Tax Code (IT) 00385040167
Economic and Administrative Index 107496 - Share Capital 60,000,000.00 EUR fully paid up

PB 22654 EN - 06.21

