

ASTRID 60x60 / 30x120

GEWISS

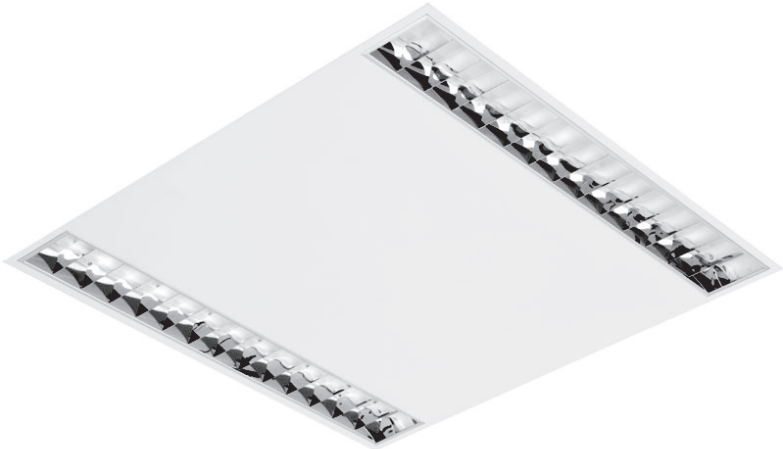

IP20



$t_{\min} -25^{\circ}\text{C}$

$t_{a} +25^{\circ}\text{C}$

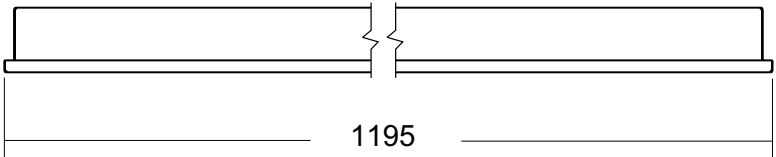
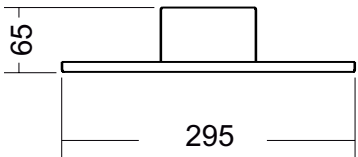
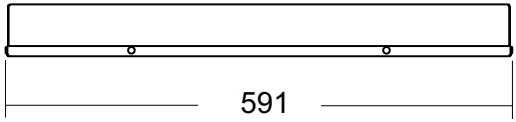
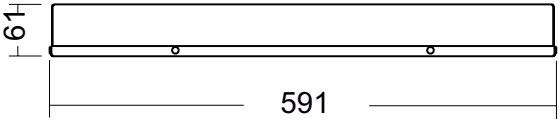

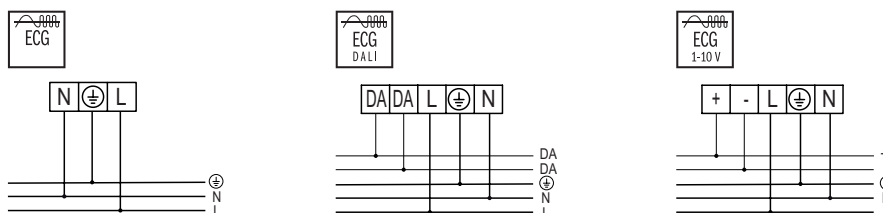
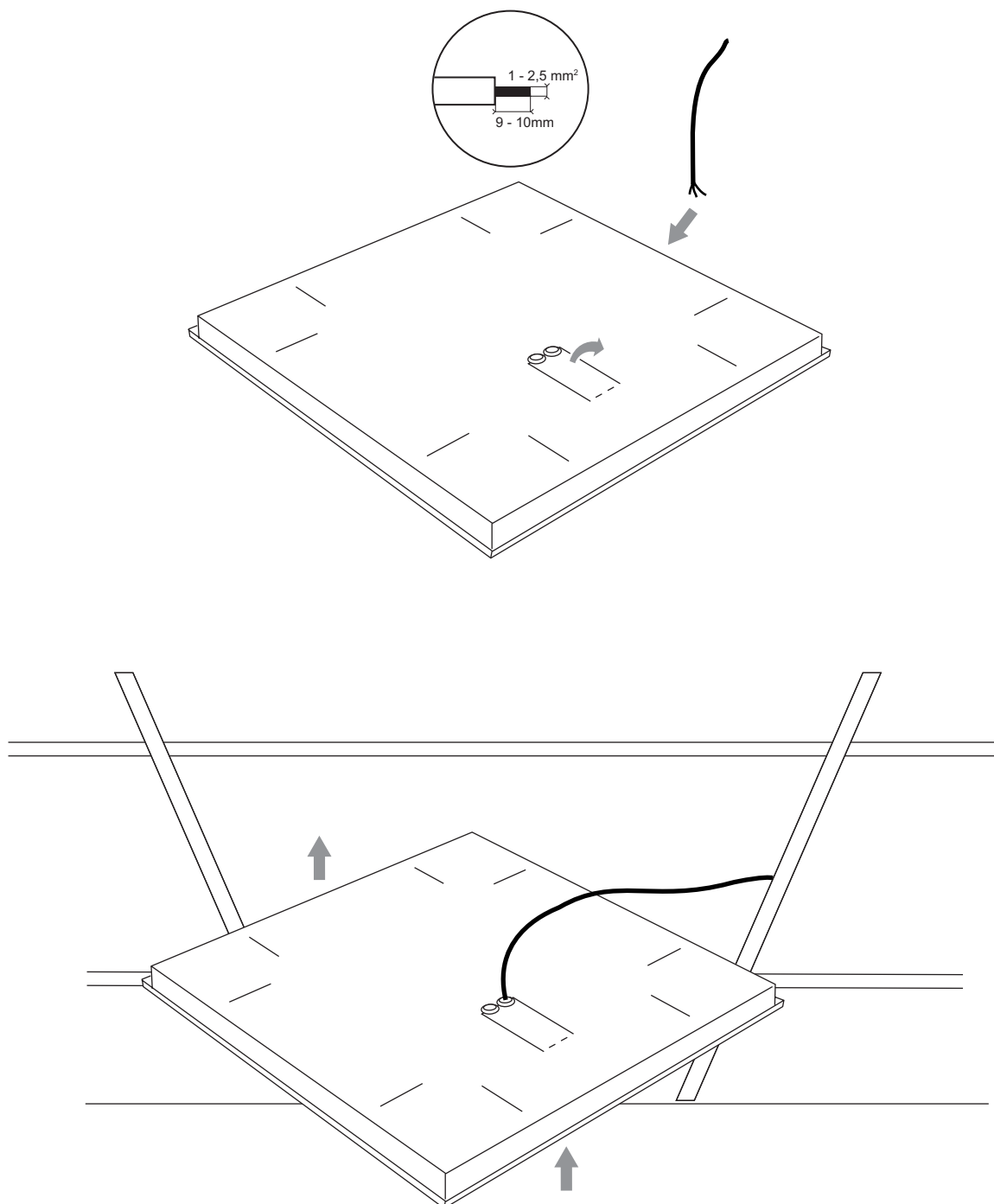

Ai sensi delle Decisioni e delle Direttive Europee applicabili, si informa che il responsabile dell'immissione del prodotto sul mercato Comunitario è:

According to the applicable Decisions and European Directives, the responsible for placing the apparatus on the Community market is:

GEWISS S.p.A. Via A.Volta, 1 IT-24069 Cenate Sotto (BG) Italy Tel: +39 035 946 111 Fax: +39 035 946 270 E-mail: qualitymarks@gewiss.com



+39 035 946 111
8.30 - 12.30 / 14.00 - 18.00
lunedì ÷ venerdì - monday ÷ friday



+39 035 946 260



sat@gewiss.com
www.gewiss.com