









DC-PV2 / DC-21B		
GW70253	GW70256	GW70259
 2 x 	 2 x 	 2 x 

Ue	Ie								
	A2+2	A4	A4 B-O-U	A2+2	A4	A4 B-O-U	A2+2	A4	A4 B-O-U
600V	29A	16A	16A	36A	25A	25A	55A	32A	32A
1200V	9A	9A	16A	12A	11A	25A	13A	13A	32A
1500V	3A	3A	16A	5A	4A	20A	6A	5A	23A

GW70291	2 x 
---------	---

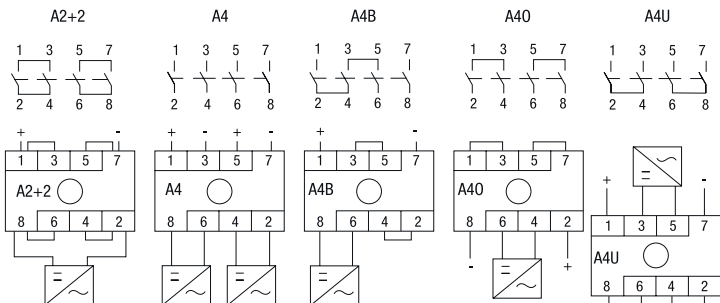

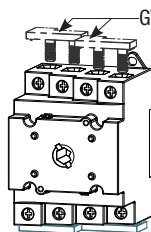
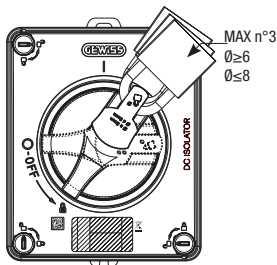
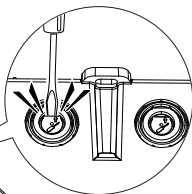
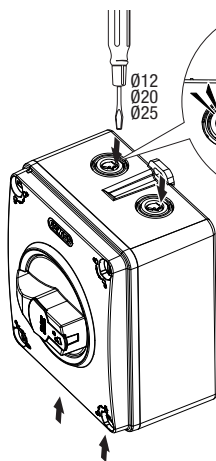
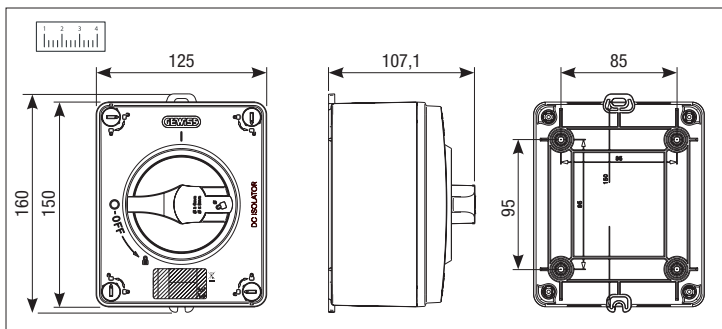

GW70291

Pz2 (M4)

1,2 - 1,5 Nm
11-13lb.inch4 - 10mm²4 - 10mm²

12mm

Punto di contatto indicato in adempimento ai fini delle direttive e regolamenti UE applicabili:

Contact details according to the relevant European Directives and Regulations:

GEWISS S.p.A. Via D.Bosatelli, 1 IT-24069 Cenate Sotto (BG) Italy
tel: +39 035 946 111 E-mail: qualitymarks@gewiss.com

According to applicable UK regulations, the company responsible for placing the goods in UK market is:

GEWISS UK LTD - Unity House, Compass Point Business Park, 9 Stocks Bridge Way, ST IVES Cambridgeshire, PE27 5JL, United Kingdom
tel: +44 1954 712757 E-mail: gewiss-uk@gewiss.com



+39 035 946 111

8:30 - 12:30 / 14:00 - 18:00
lunedì - venerdì / monday - friday



www.gewiss.com

