

GW 38 346

8 F.O.	50M	Ø 3,8 mm
--------	-----	----------

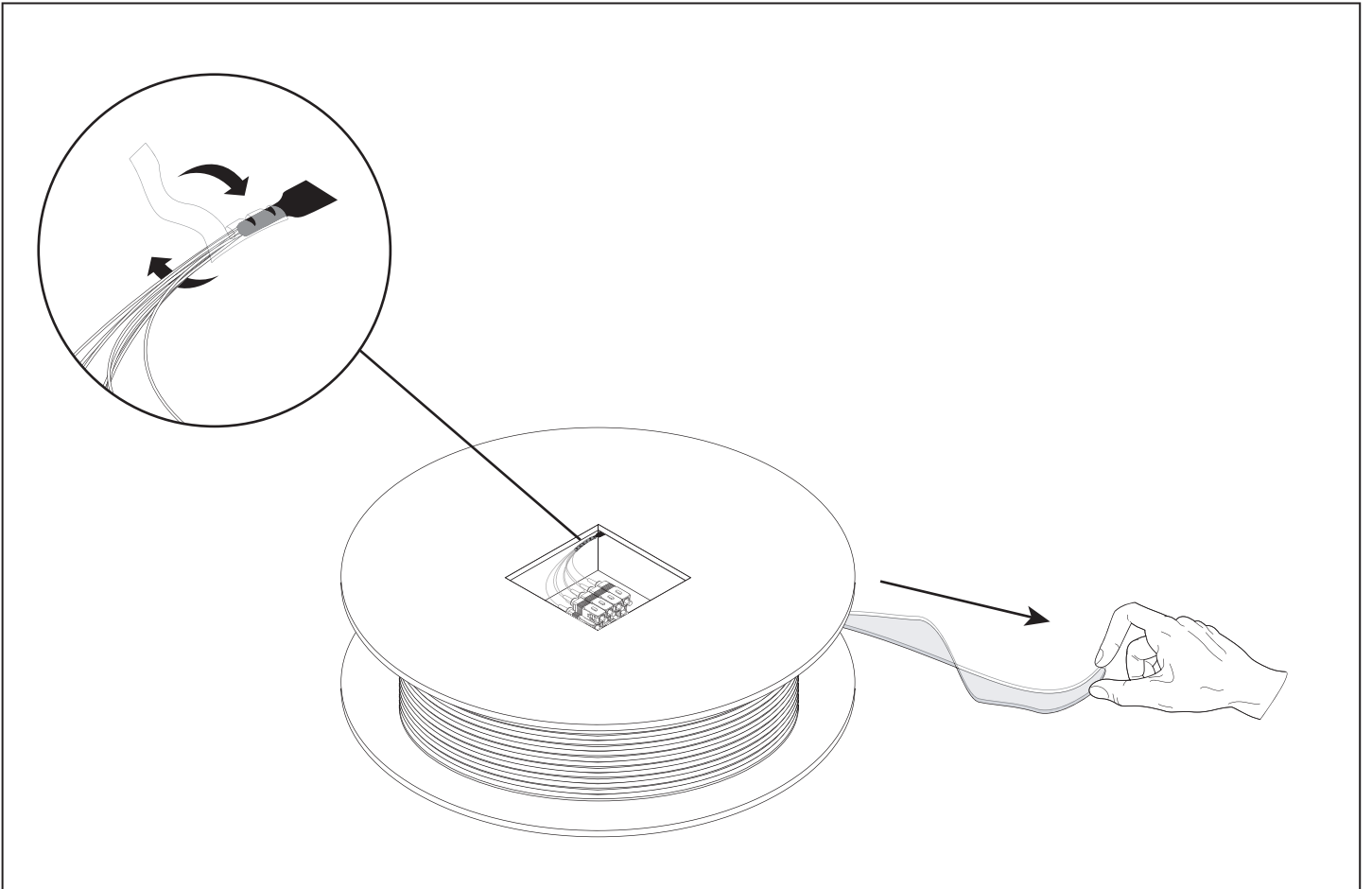

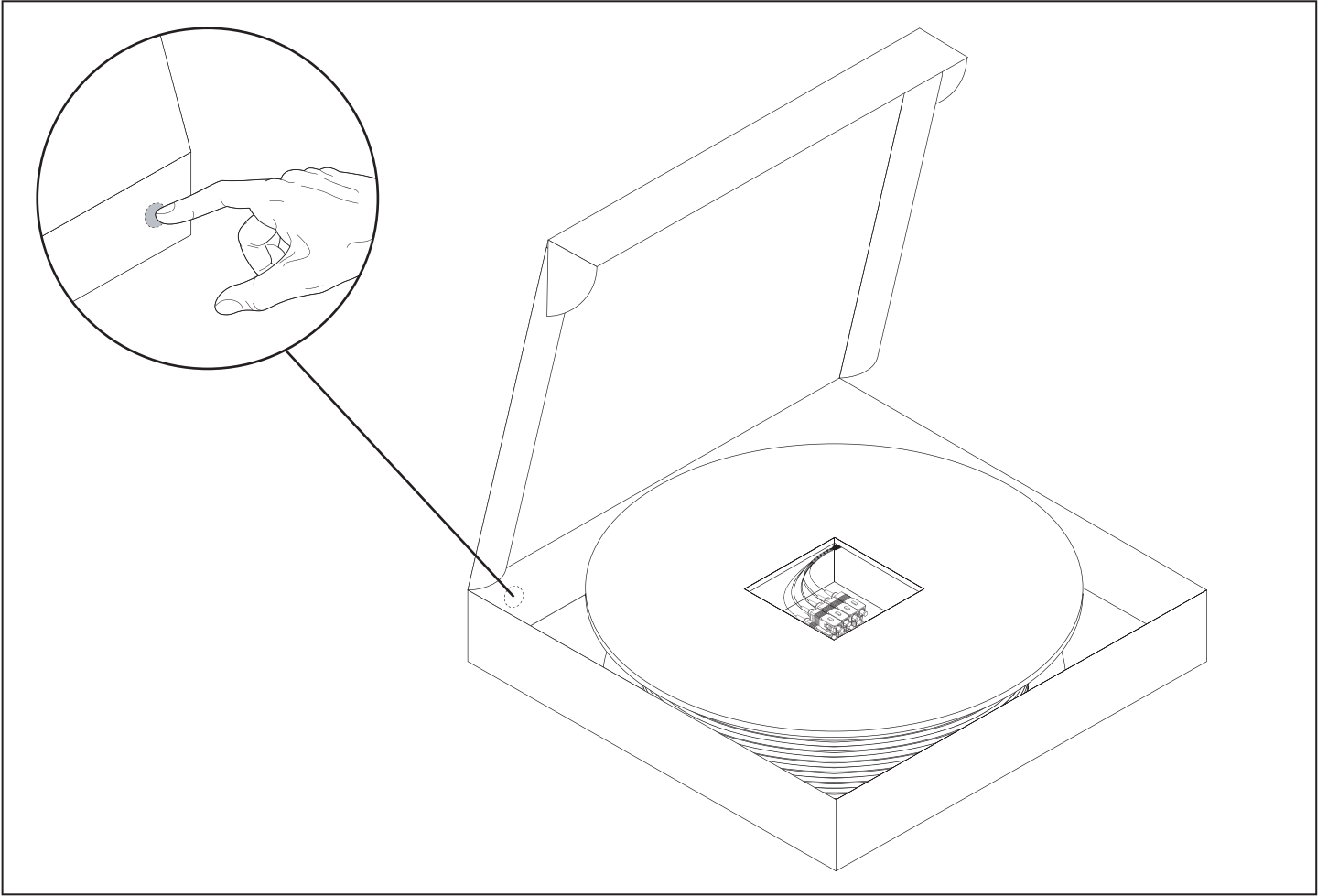

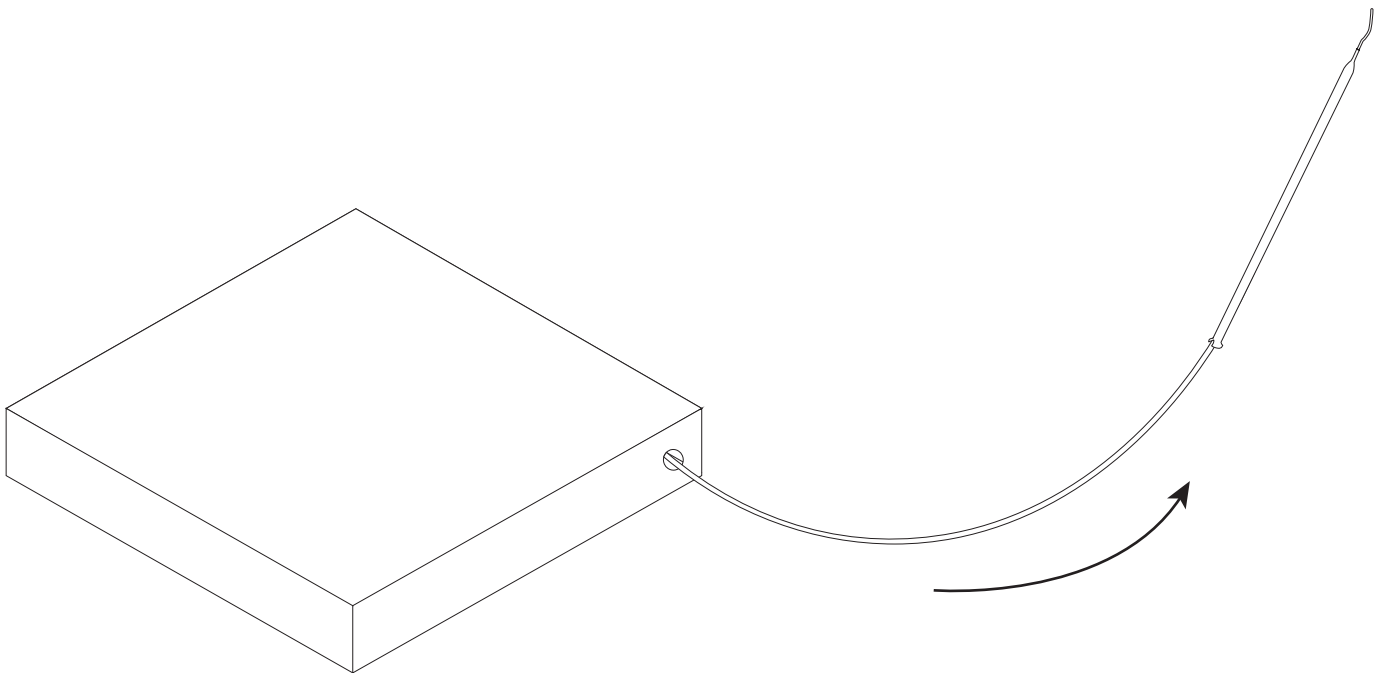
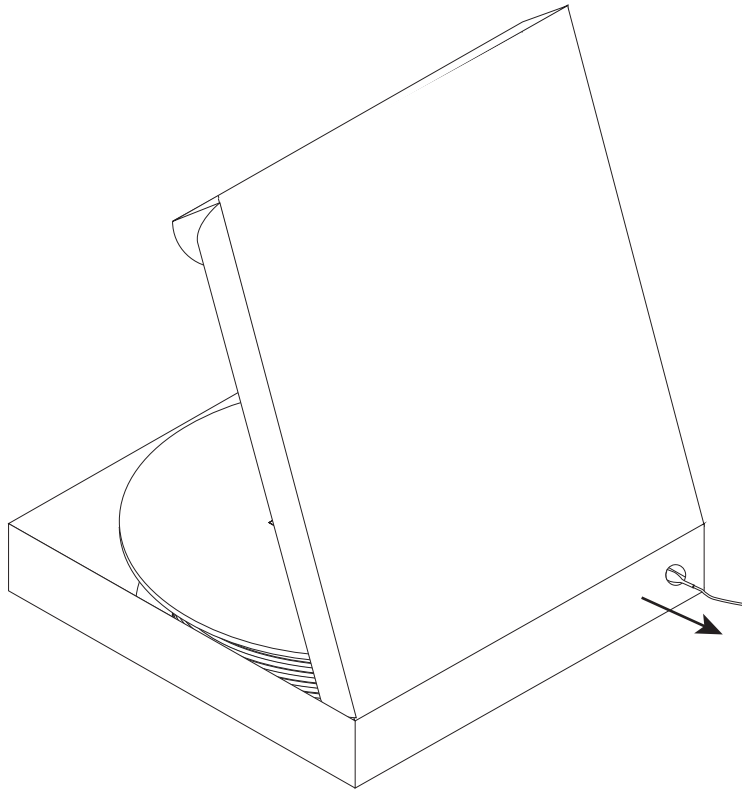
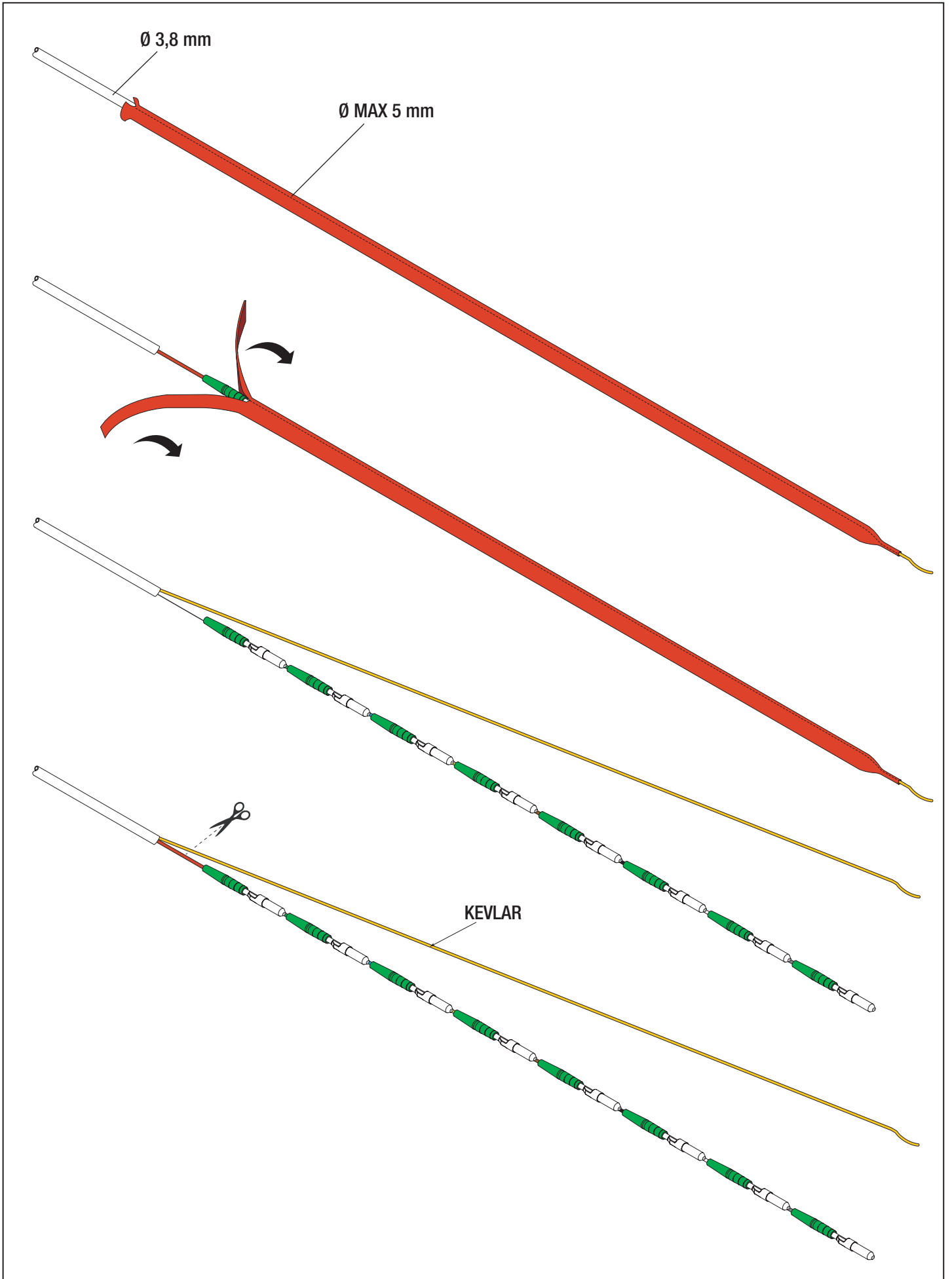

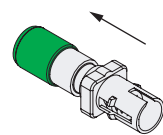
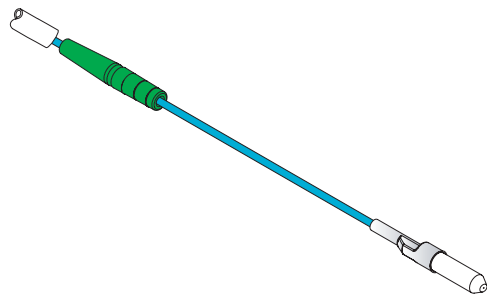
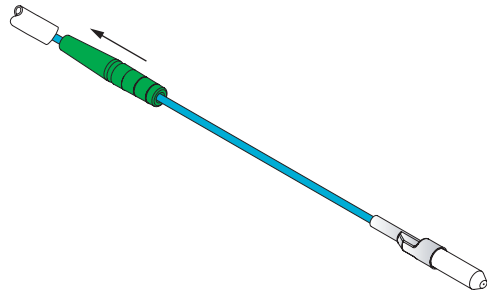
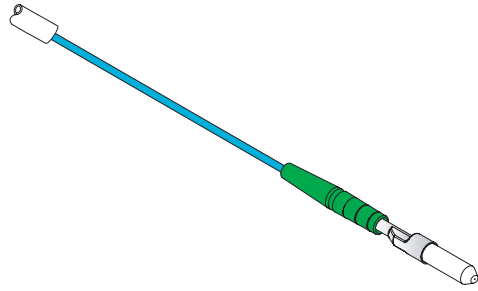

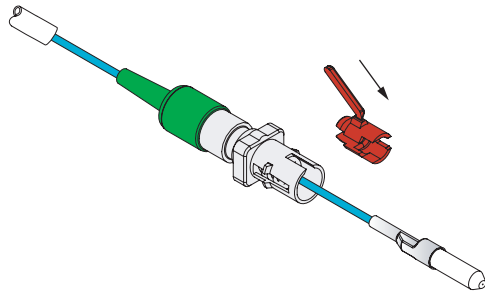
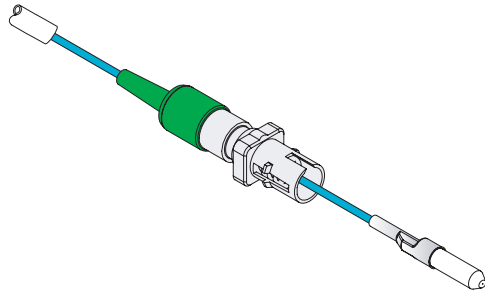
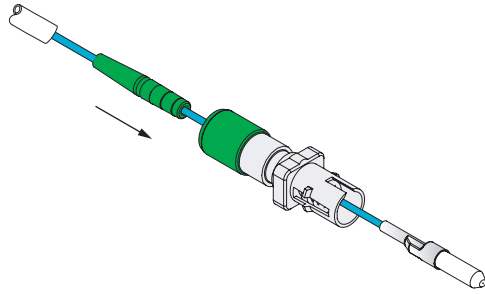

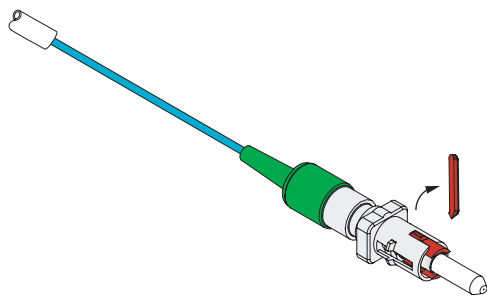
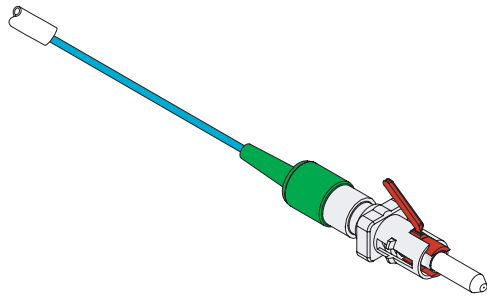
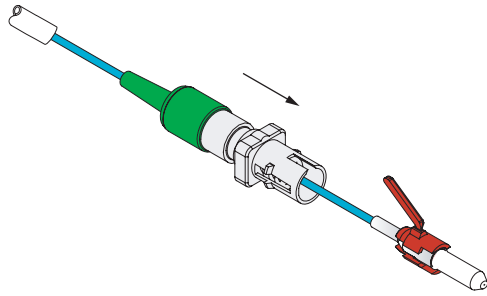

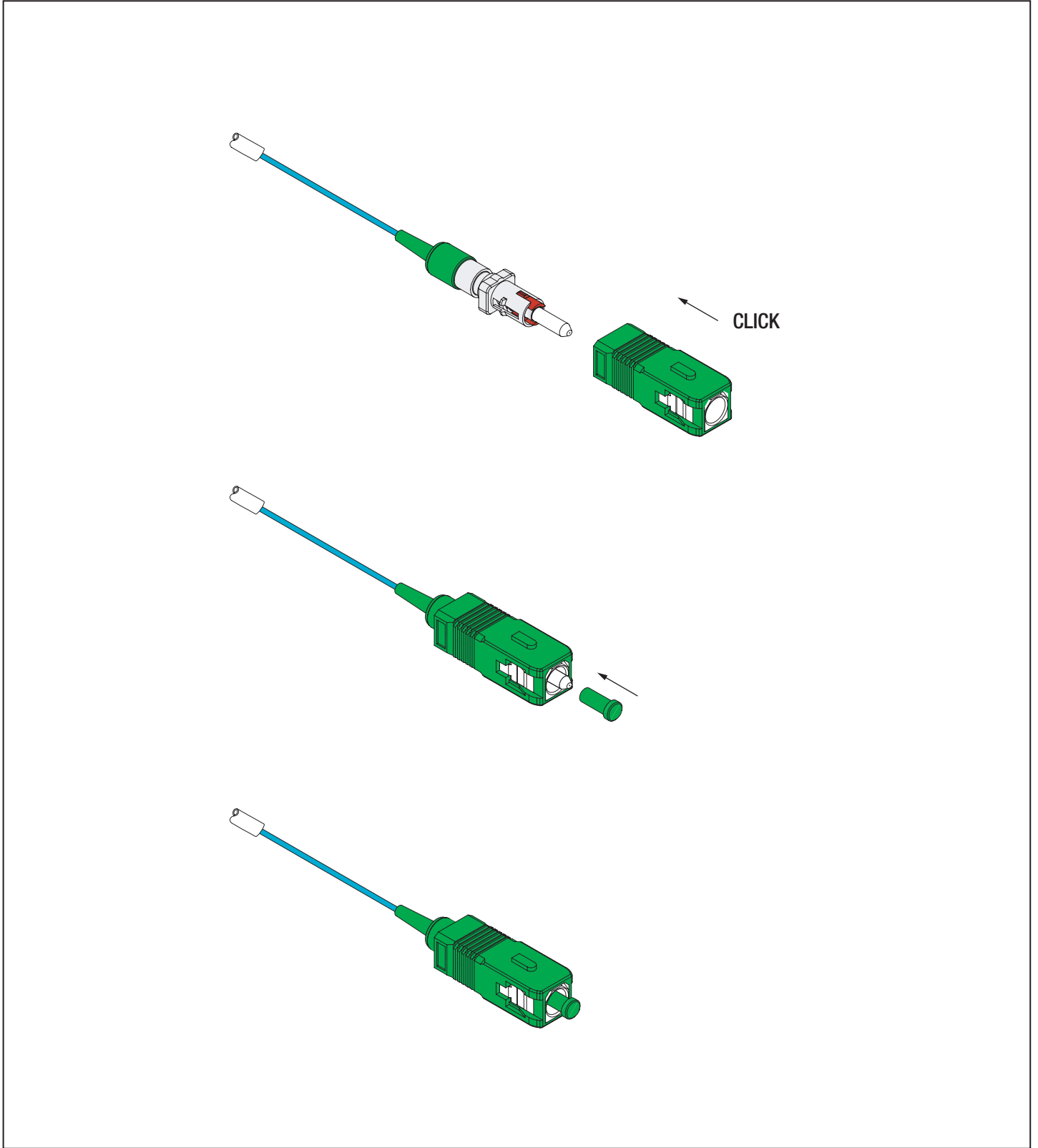

Punto di contatto indicato in adempimento ai fini delle direttive e regolamenti UE applicabili:
Contact details according to the relevant European Directives and Regulations:

GEWISS S.p.A. Via A.Volta, 1 IT-24069 Cenate Sotto (BG) Italy tel: +39 035 946 111 E-mail: qualitymarks@gewiss.com



+39 035 946 111
8.30 - 12.30 / 14.00 - 18.00
lunedì - venerdì - monday - friday



+39 035 946 260



sat@gewiss.com
www.gewiss.com