

Dati tecnici

QDX 630H	
Caratteristiche elettriche	Caratteristiche meccaniche
Normativa: EN 61439-1 e EN 61439-2, EN 62208	Grado di protezione: IP 30 senza porta
Corrente nominale (In): fino a 250 A (parete), fino a 630 A (pavimento)	IP 55 con porta in vetro/cieca
Tensione nominale di impiego (Ue): fino a 400 V ac	Grado di resistenza: IK 09 per porta in vetro
Tensione nominale di isolamento (Ui): fino a 690 V ac	IK 10 per porta cieca
Tensione nominale di tenuta a impulso (Uimp): 6-8-12 kV 1,2/50 µs	Temperatura di funzionamento: -5 °C ÷ 40 °C
Corrente nominale di breve durata per 1s (Icw): 20 kA (parete), 35kA (pavimento)	Temperatura di immagazzinamento: -25 °C ÷ 55 °C
Protezione contro i contatti indiretti: involucro metallico predisposto per messa a terra	Spessore lamiera d'acciaio struttura: 15/10 mm
	Spessore lamiera zincata accessori: 15/10-20/10-25/10 mm
	Verniciatura delle lamiere con polveri epossidiche previa fosfatazione colore Grigio RAL 7035 bucciato

CARATTERISTICHE FUNZIONALI

Tipo di installazione: ambienti interni	Zoccolo (altezza 100 mm) palettizzabile tramite rimozione pannello anteriore e posteriore
Capacità: 24/35 moduli EN 50022 per fila	Predisposizione per l'affiancamento delle strutture con l'apposito kit (solo per quadri da pavimento)
Ingresso cavi superiore e inferiore tramite piastre passacavi in metallo	Possibilità di fissaggio a muro della struttura
Montanti funzionali interni con foratura passo 25 mm per il montaggio dei kit d'installazione degli apparecchi	Messa a terra per contatto delle parti metalliche
Segregazione: forma 1 e forma 2a (pavimento)	Montaggio porta con apertura reversibile (lato destro o sinistro)
	Accessibilità quadro frontale, laterale e posteriore

Table dimensionali

STRUTTURA QUADRO DA PARETE

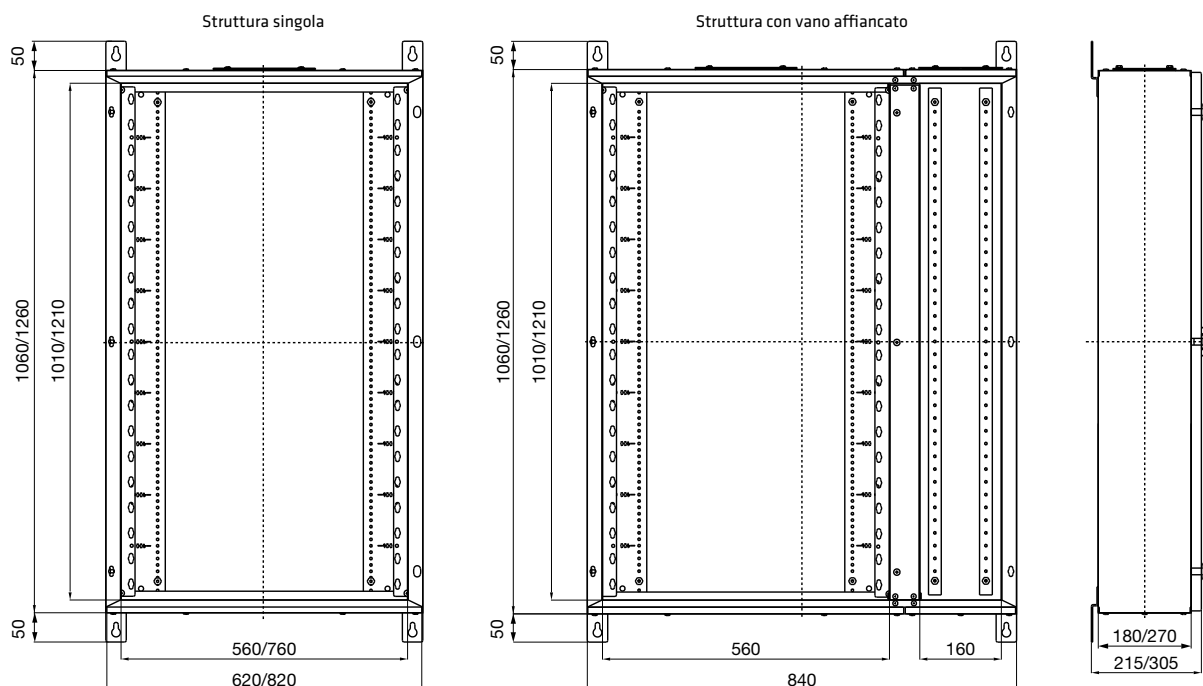

STRUTTURA QUADRO DA PAVIMENTO

Calcolo ingombro di n strutture (colonne) affiancate

Larghezza (mm) = $(B1+B2+...+Bn)+50$

Bn = larghezza colonna n (mm)

50 = ingombro di 2 pannelli laterali

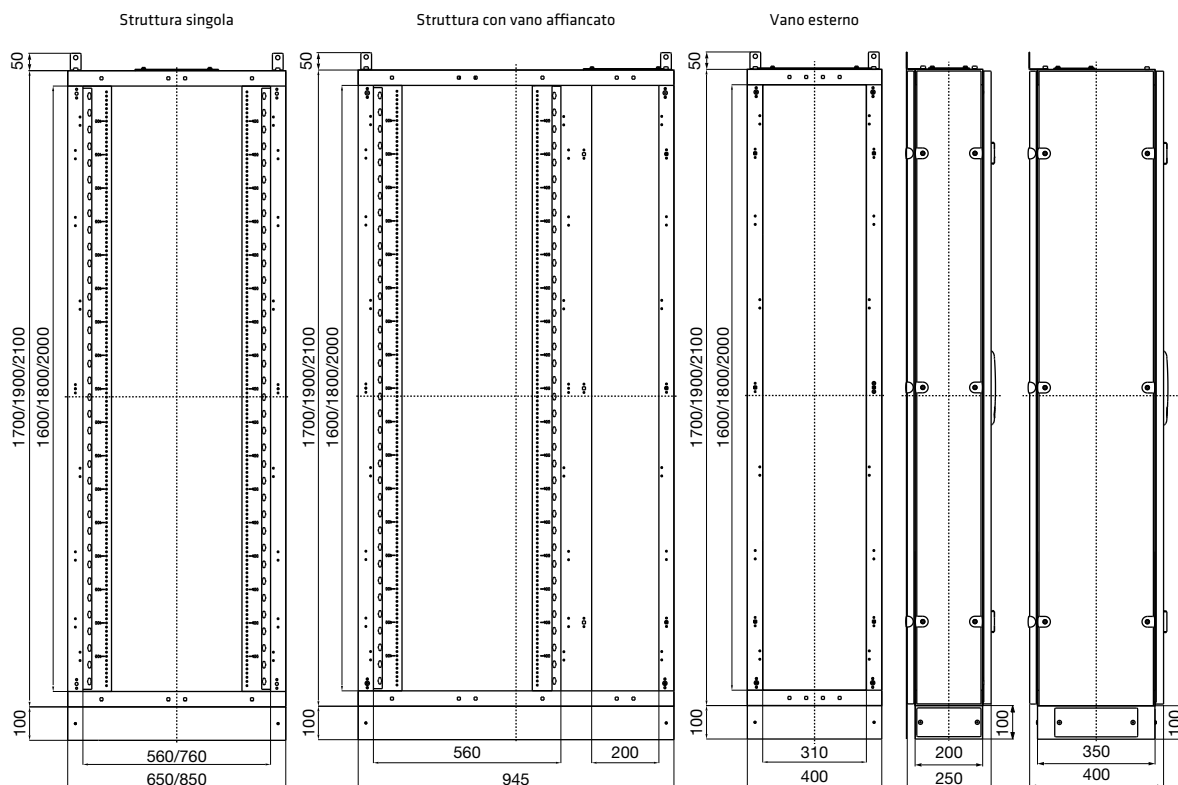

PORTE PER QUADRO DA PARETE

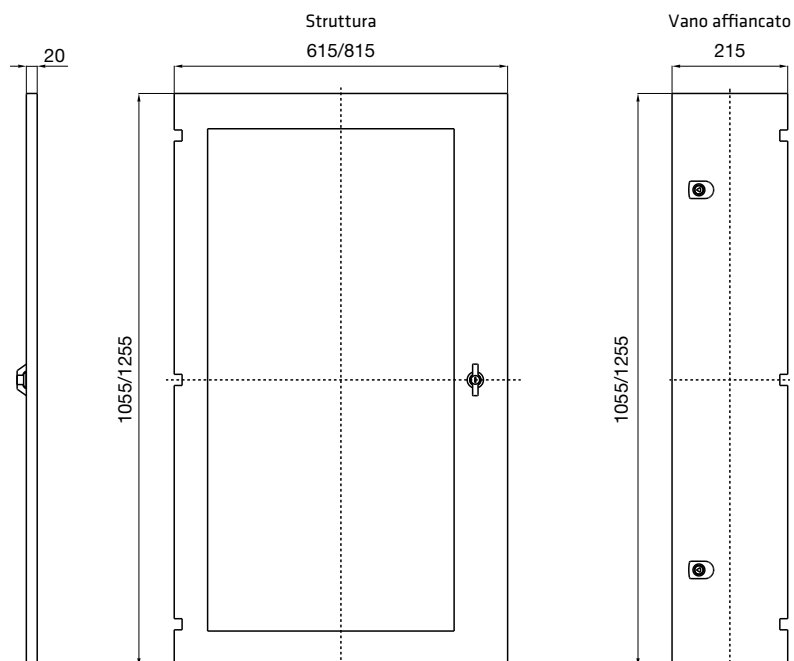

PORTE PER QUADRO DA PAVIMENTO

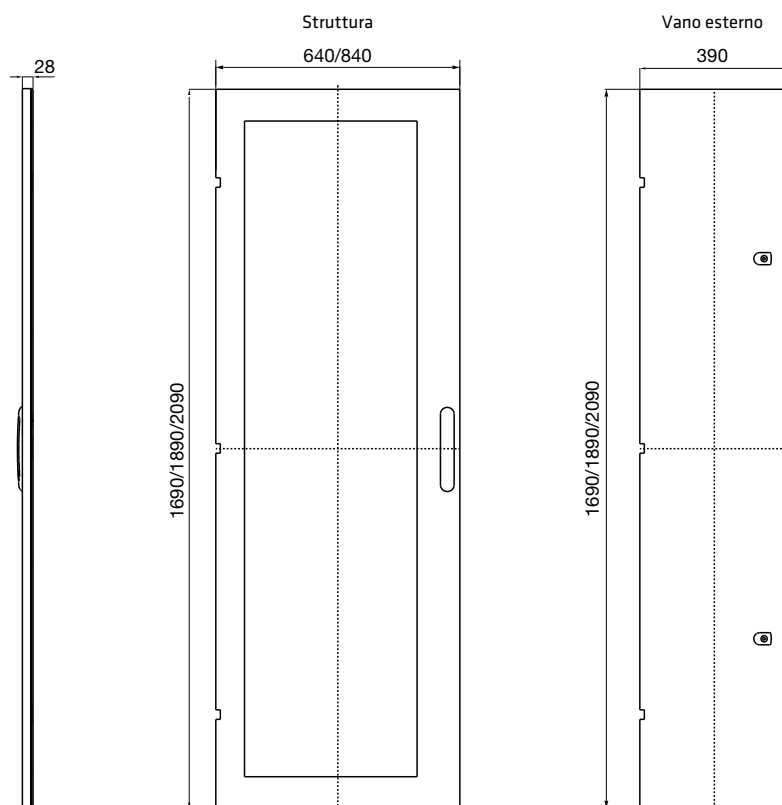

FISSAGGIO QUADRO A PARETE

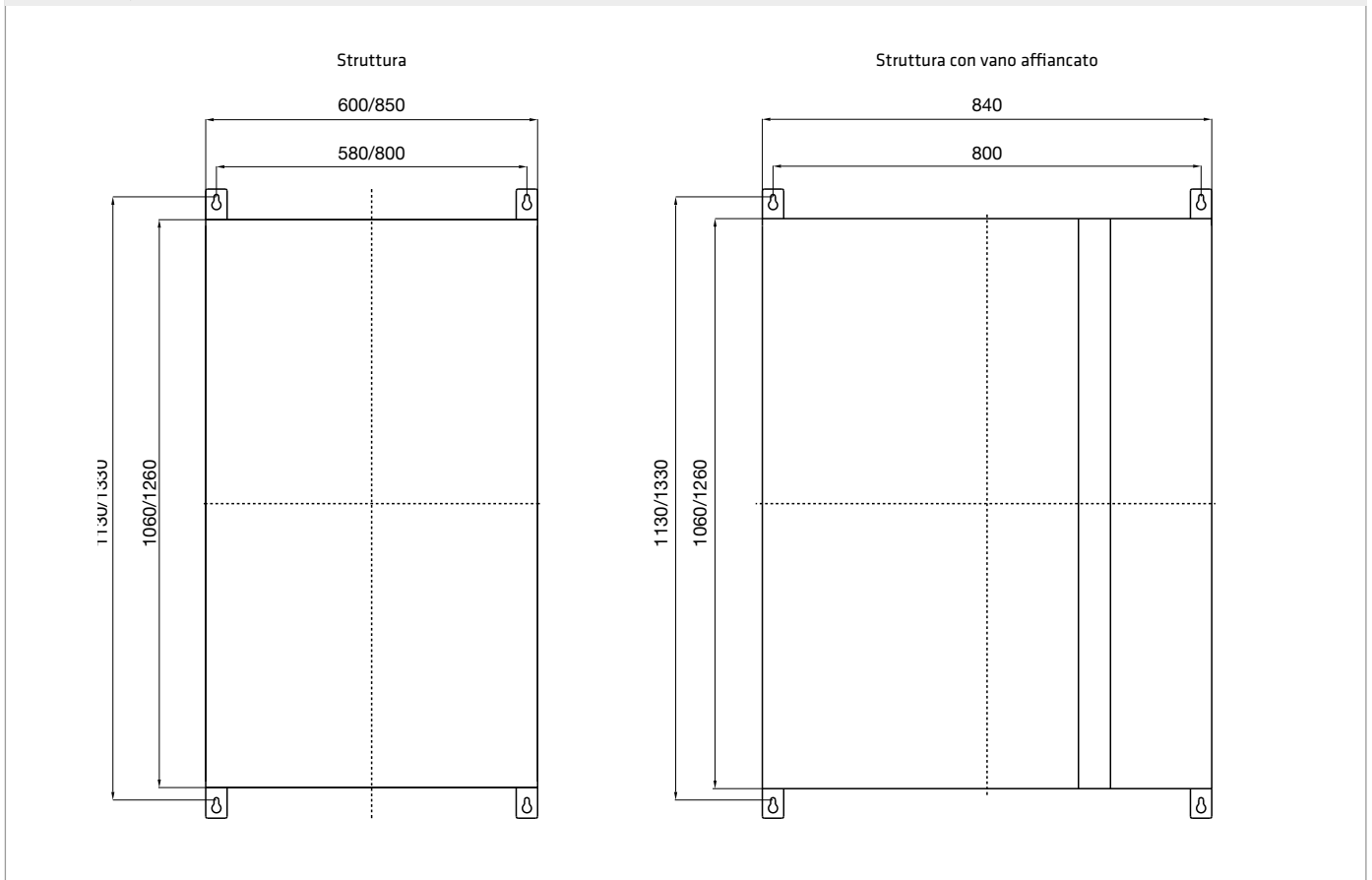

FISSAGGIO QUADRO A PAVIMENTO

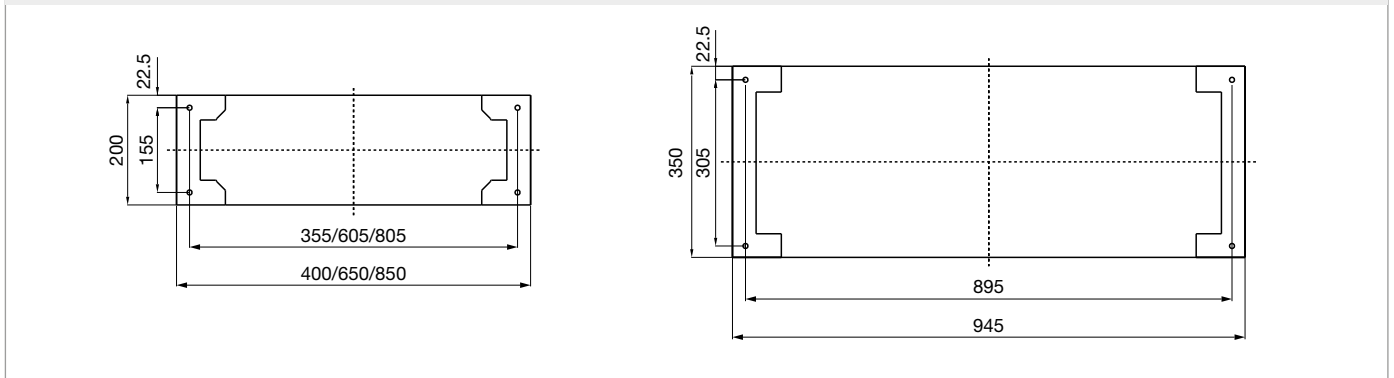

SEZIONE STRUTTURA QUADRO A PARETE

QUADRI DA PARETE

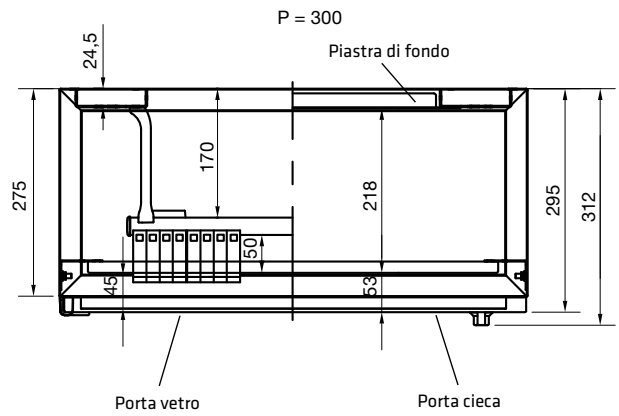
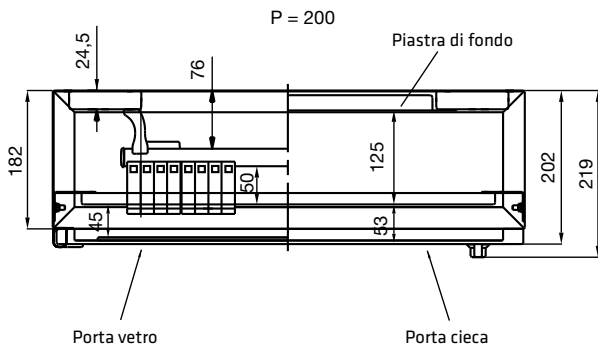

SEZIONE STRUTTURA QUADRO A PAVIMENTO

QUADRI DA PAVIMENTO

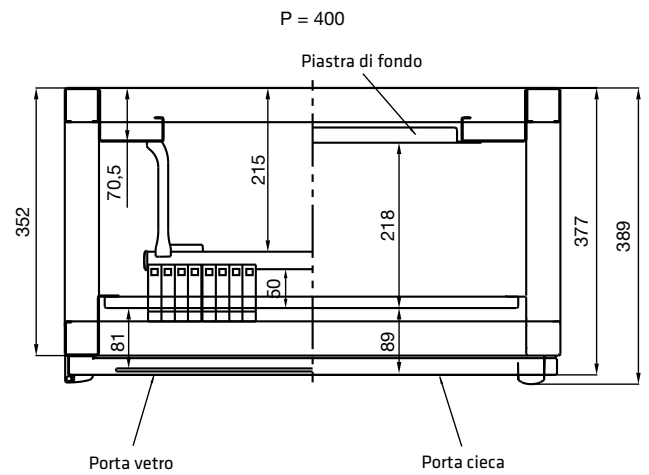
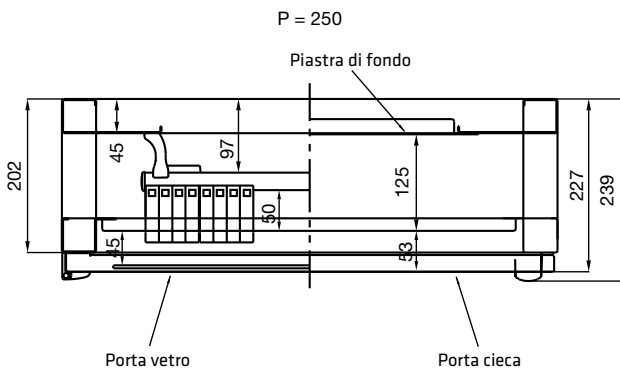

INGRESSO CAVI PER QUADRI DA PARETE (SUPERIORE/INFERIORE)

Struttura singola B=600

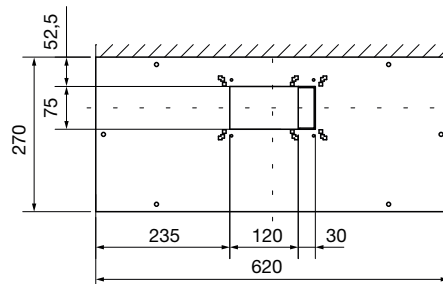
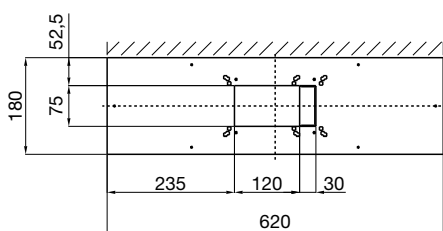

Struttura singola B=850

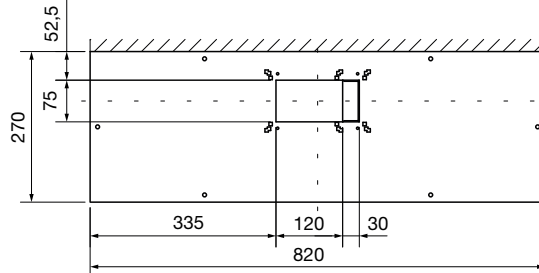
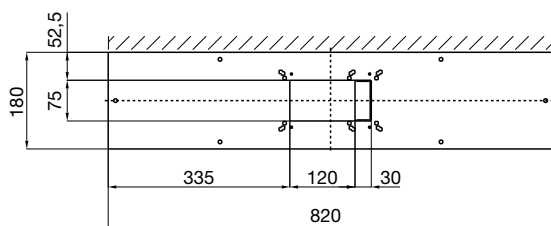

Struttura con vano affiancato

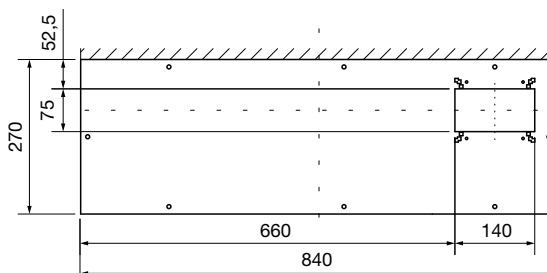
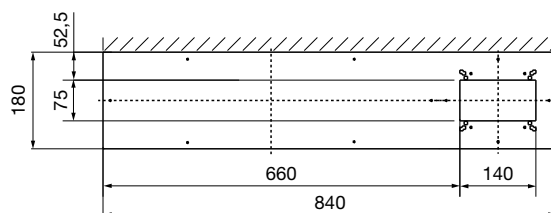

INGRESSO CAVI PER QUADRI DA PAVIMENTO

Struttura singola

Inferiore

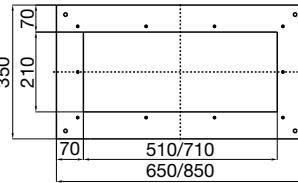
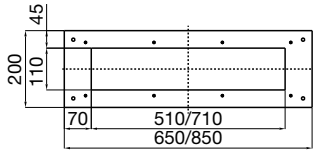

Vano esterno

Inferiore

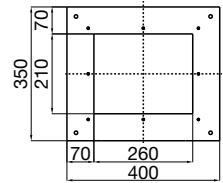
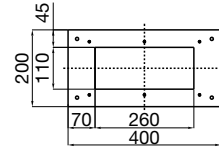

Superiore

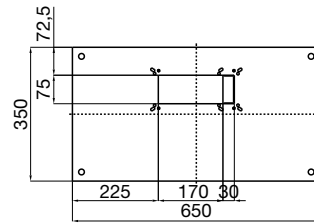
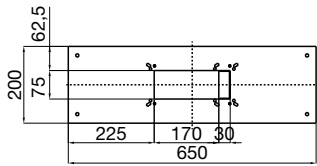

Superiore

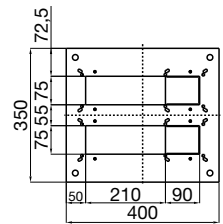
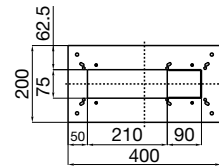

Superiore

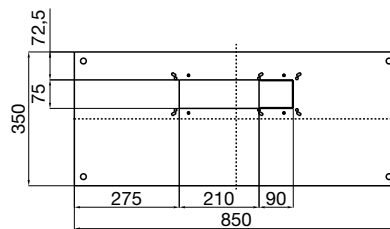
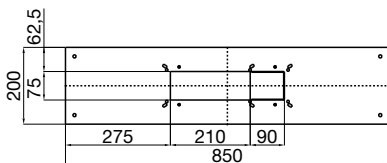

Struttura con vano affiancato

Inferiore

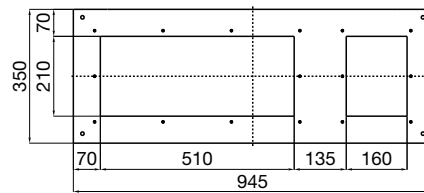
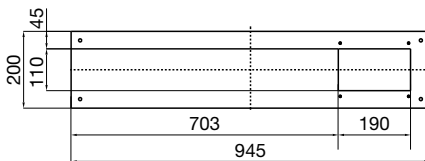

Superiore

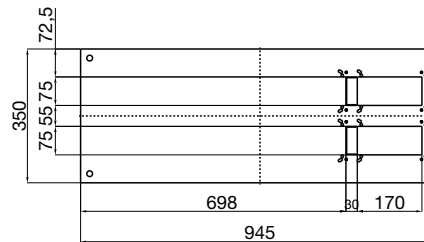
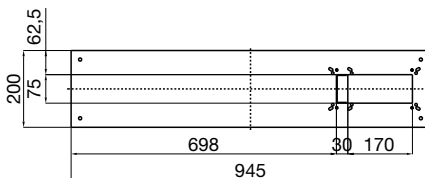

PANNELLI FINESTRATI

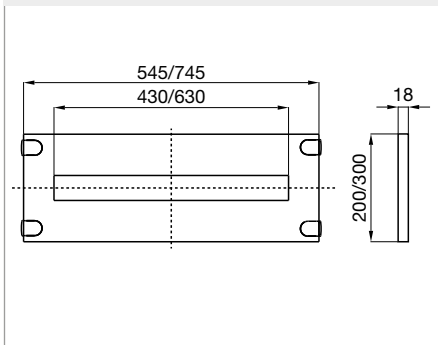

PANNELLI CIECHI

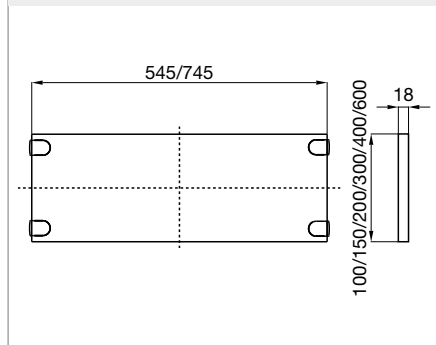

PIASTRE DI FONDO

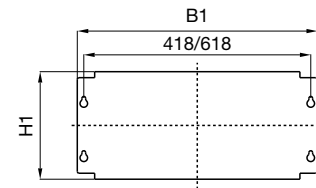

Dimensioni funzionali		Dimensioni utili	
B (mm)	H (mm)	B1 (mm)	H1 (mm)
600	200	442	198
600	400	442	398
600	600	442	598
600	800	442	798
600	1000	442	998
850	200	642	198
850	400	642	398
850	600	642	598
850	800	642	798
850	1000	642	998