

Technical data

QDX 630H	
Electrical characteristics	Mechanical characteristics
Standards: EN 61439-1 and EN 61439-2, EN 62208	Degree of protection: IP 30 without door
Rated current (In): up to 250 A (wall-mounting), up to 630 A (floor-mounting)	IP 55 with glass/solid door
Rated operational voltage (Ue): up to 400 V ac	Impact resistance: IK 09 for glass door
Rated insulation voltage (Ui): up to 690 V ac	IK 10 for solid door
Rated impulse withstand voltage (Uimp): 6-8-12 kV 1.2/50 µs	Operating temperature: -5 °C ÷ 40 °C
Rated short-time withstand current for 1s (Icw): 20 kA (wall-mounting), 35 kA (floor-mounting)	Storage temperature: -25 °C ÷ 55 °C
Protection against indirect contacts: metal casing prearranged for earth connection	Sheet steel casing: 15/10 mm thick
	Galvanized metal sheet accessories: 15/10-20/10-25/10 mm thick
	Sheet metal painted with textured colour Grey RAL 7035 epoxy-polyester powder after phosphating

FUNCTIONAL CHARACTERISTICS	
Type of installation: indoors	Plinth (height 100 mm) palletizable by removing the front and rear panels
Capacity: 24/35 EN 50022 modules per row	Structures can be mounted side by side using the provided kit (only for floor-mounting boards)
Top and bottom cable entry through metal cable gland plates	Structure can be wall-mounted
Internal functional uprights with 25mm pitch drilled for the assembly of the equipment installation kits	Earthing by contact of metal parts
Segregation: form 1 and form 2a (floor-mounting)	Door assembly with reversible opening (right or left side)
	Board accessibility: front, side and rear

Dimension tables

STRUCTURE OF WALL-MOUNTING BOARD

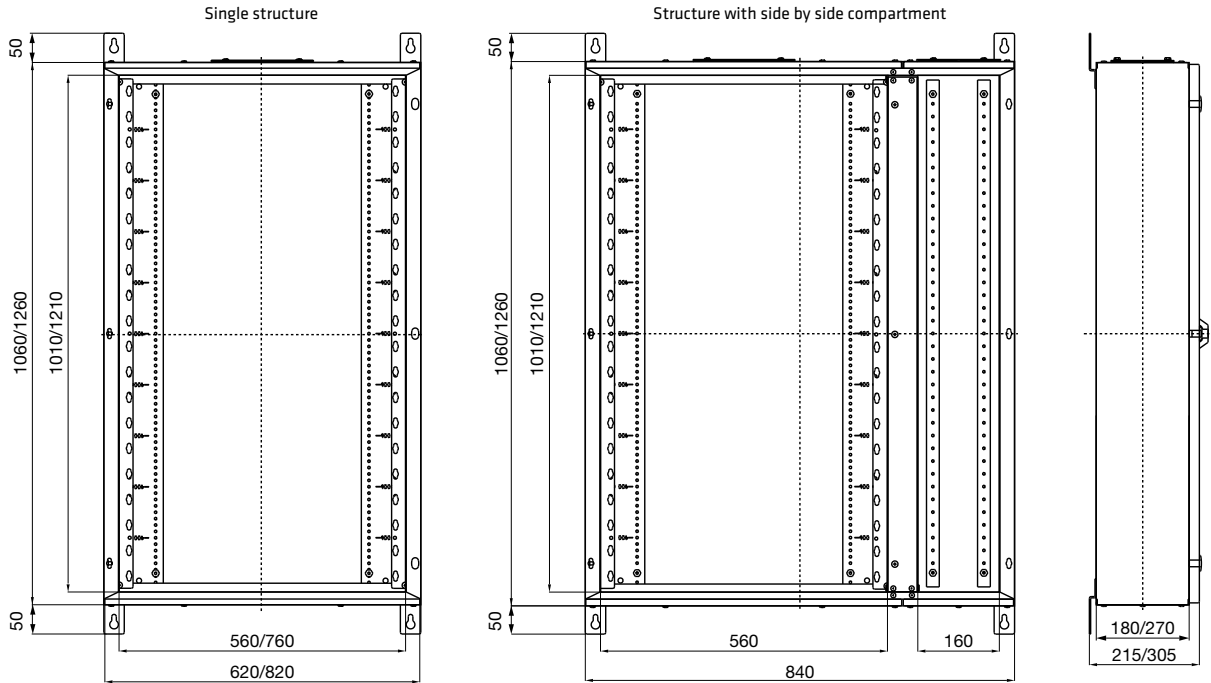

STRUCTURE OF FLOOR-MOUNTING BOARD

Size calculation of side by side n-structures (columns)
 Width (mm) = (B1+B2+...+Bn)+50
 Bn = nth column width (mm)
 50 = size of 2 side panels

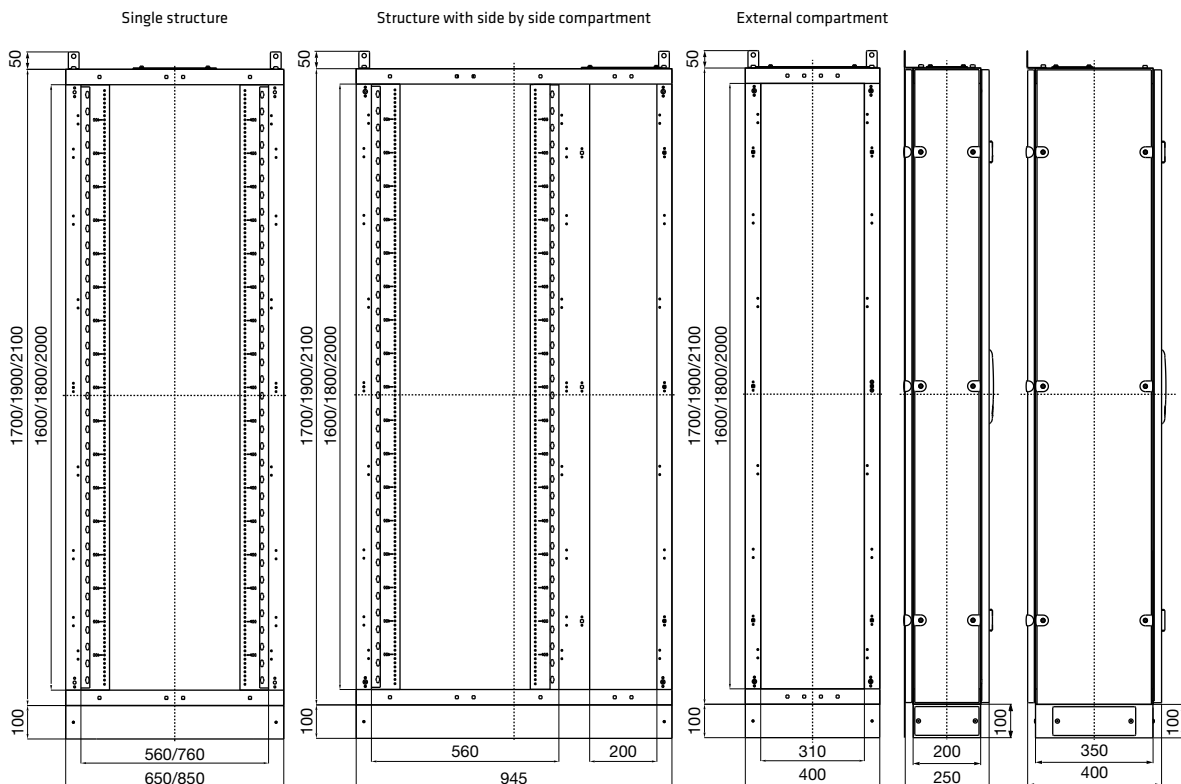

For technical information contact the Technical Assistance Service or visit gewiss.com

DOORS FOR WALL-MOUNTING BOARD

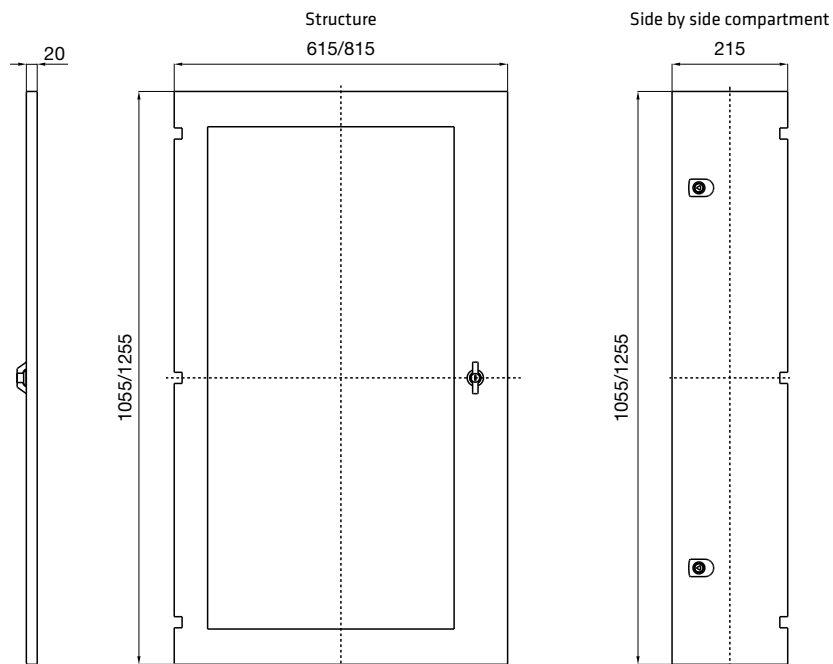

DOOR FOR FLOOR-MOUNTING BOARD

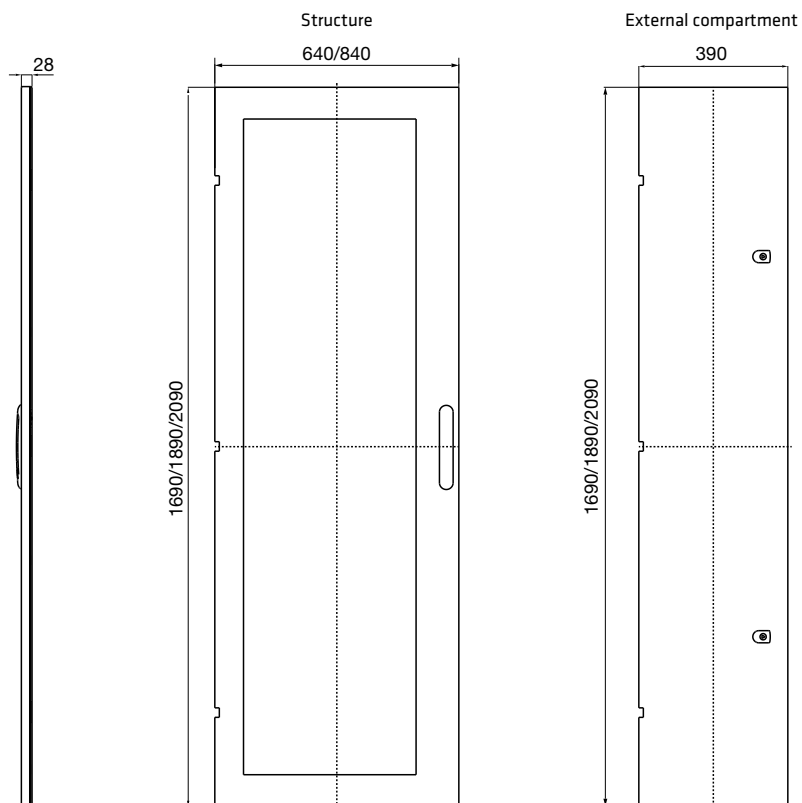

WALL-MOUNTING BOARD INSTALLATION

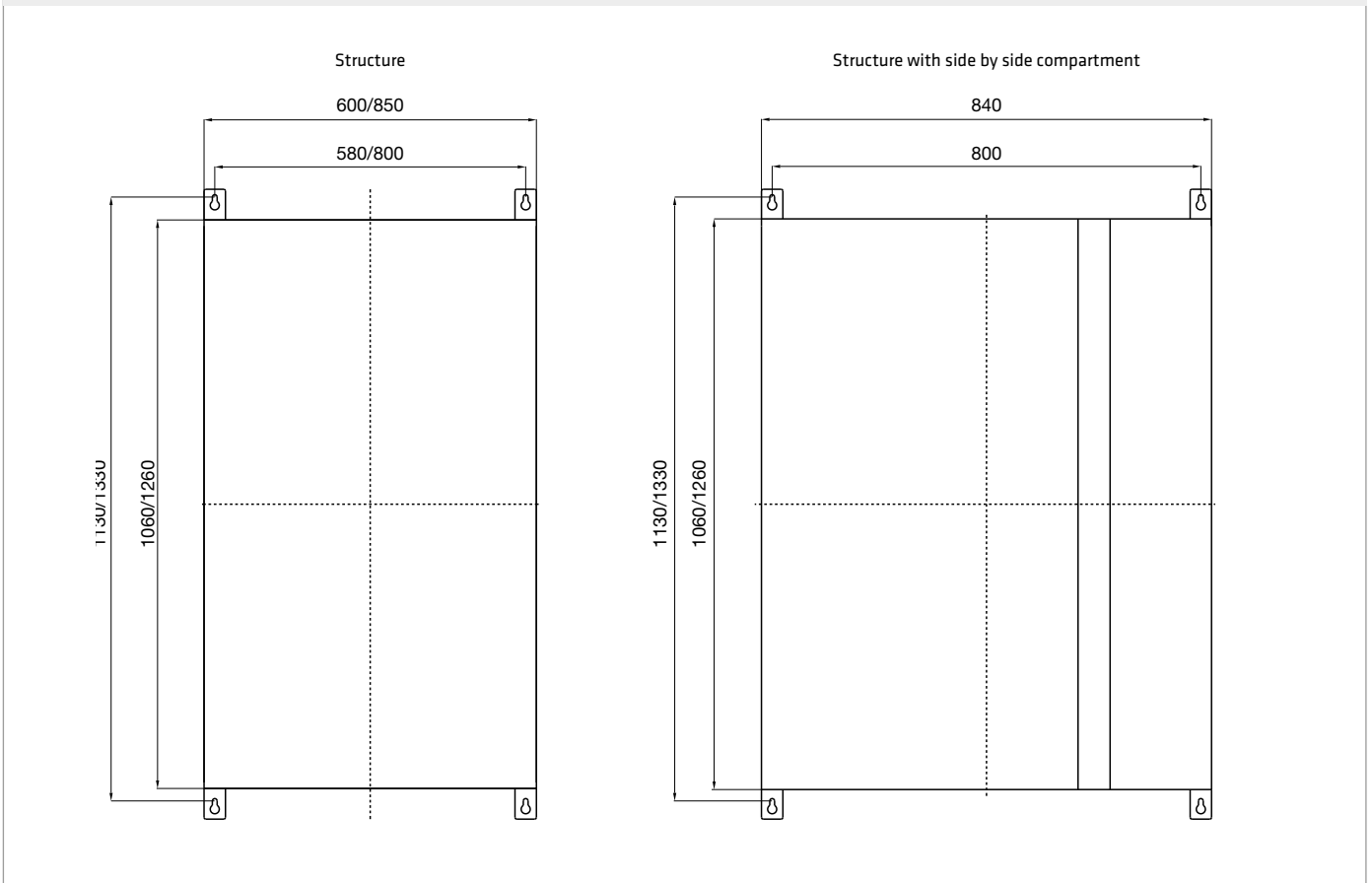

FLOOR-MOUNTING BOARD INSTALLATION

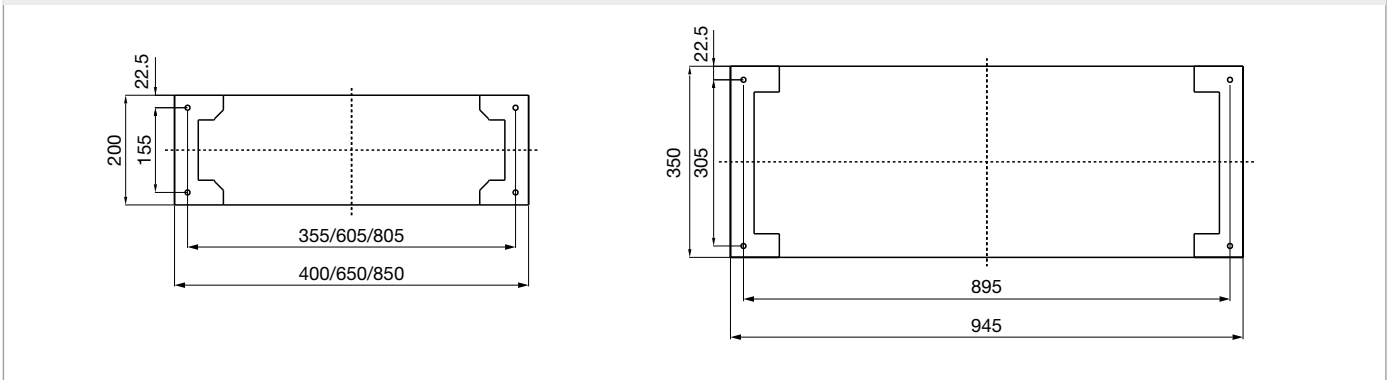

WALL-MOUNTING BOARD STRUCTURE SECTION

WALL-MOUNTING BOARDS

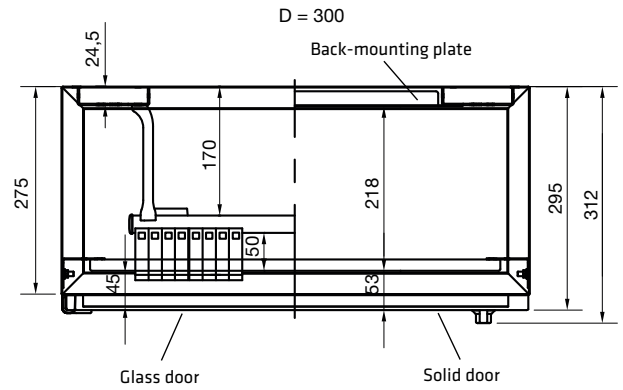
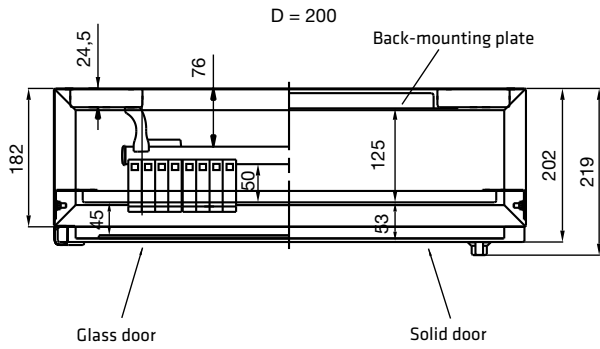

FLOOR-MOUNTING BOARD STRUCTURE SECTION

FLOOR-MOUNTING BOARDS

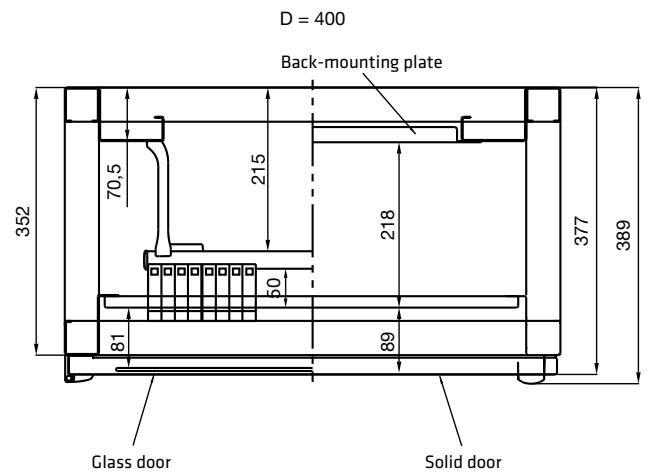
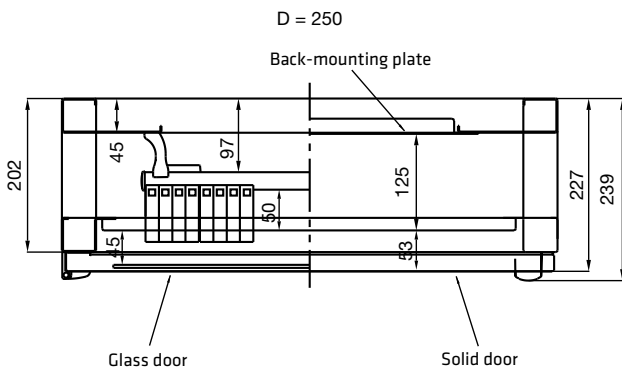

WALL-MOUNTING BOARDS CABLE ENTRY (TOP/BOTTOM)

Single structure B=600

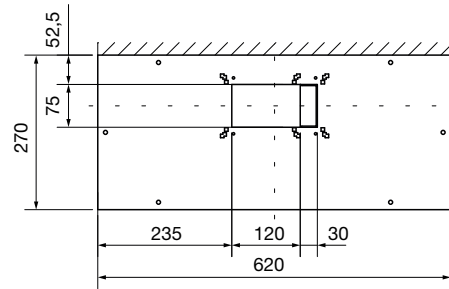
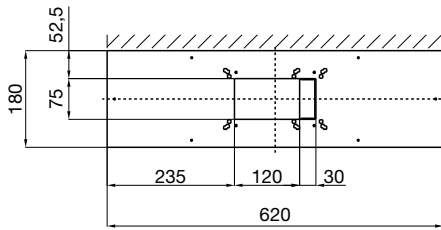

Single structure B=850

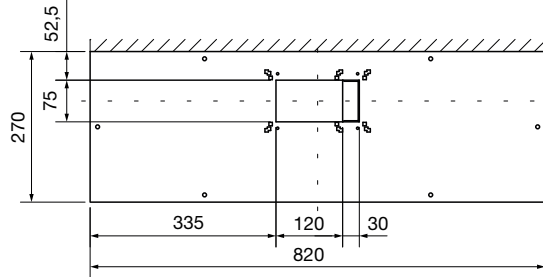
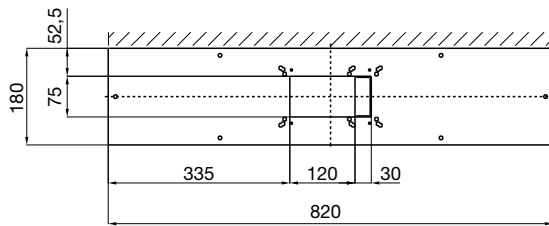

Structure with side by side compartment

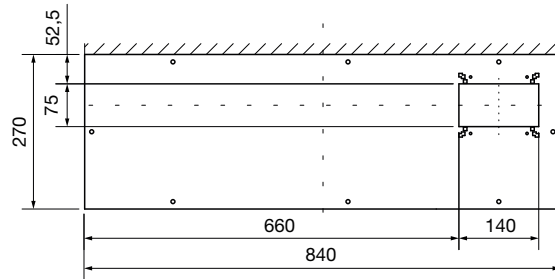
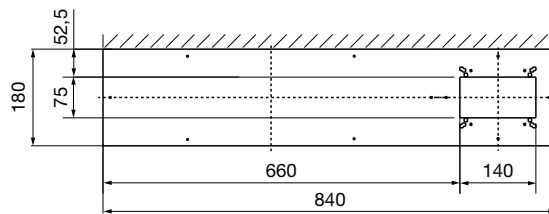

FLOOR-MOUNTING BOARDS CABLE ENTRY

Single structure

Bottom

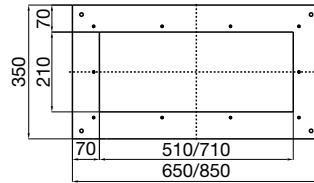
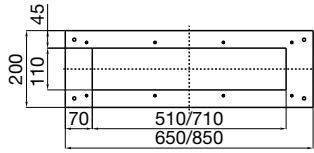

External compartment

Bottom

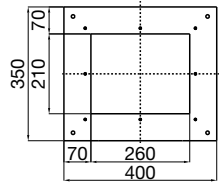
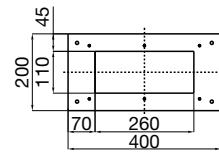

Top

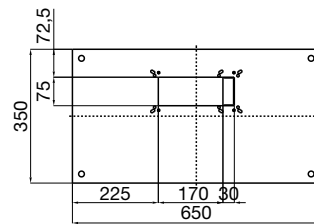
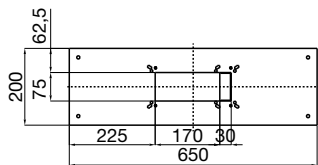

Top

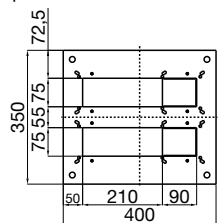
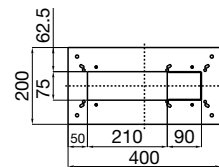

Top

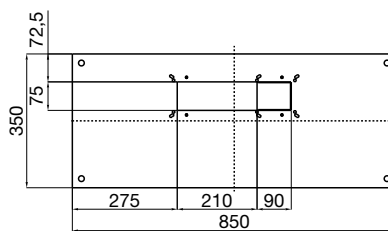
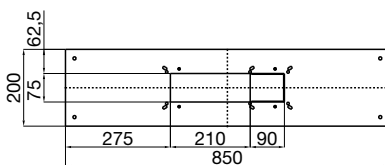

Structure with side by side compartment

Bottom

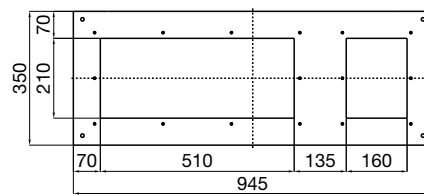
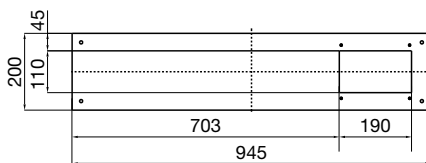

Top

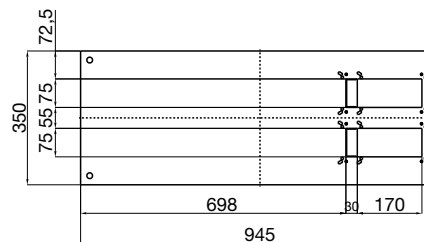
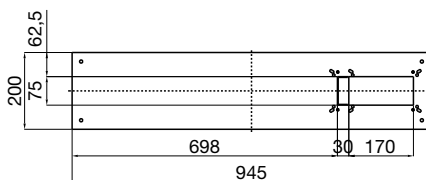

WINDOWED PANELS

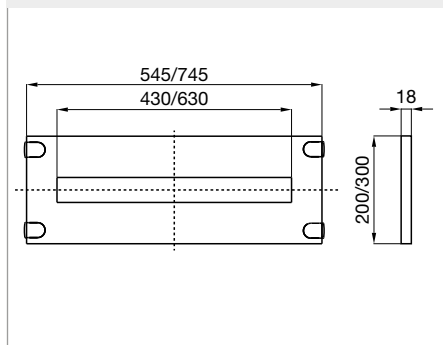

SOLID PANELS

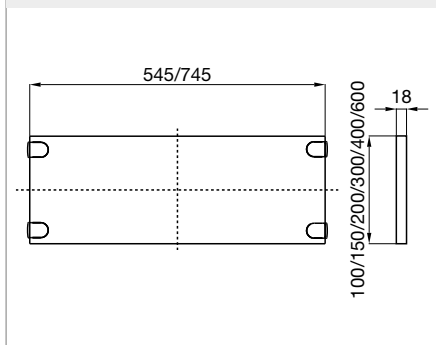

BACK-MOUNTING PANELS

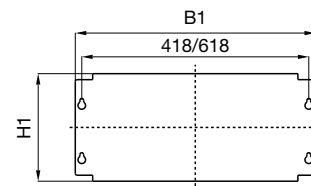

Functional dimensions		Real dimensions	
B (mm)	H (mm)	B1 (mm)	H1 (mm)
600	200	442	198
600	400	442	398
600	600	442	598
600	800	442	798
600	1000	442	998
850	200	642	198
850	400	642	398
850	600	642	598
850	800	642	798
850	1000	642	998