

# Building

Technical characteristics

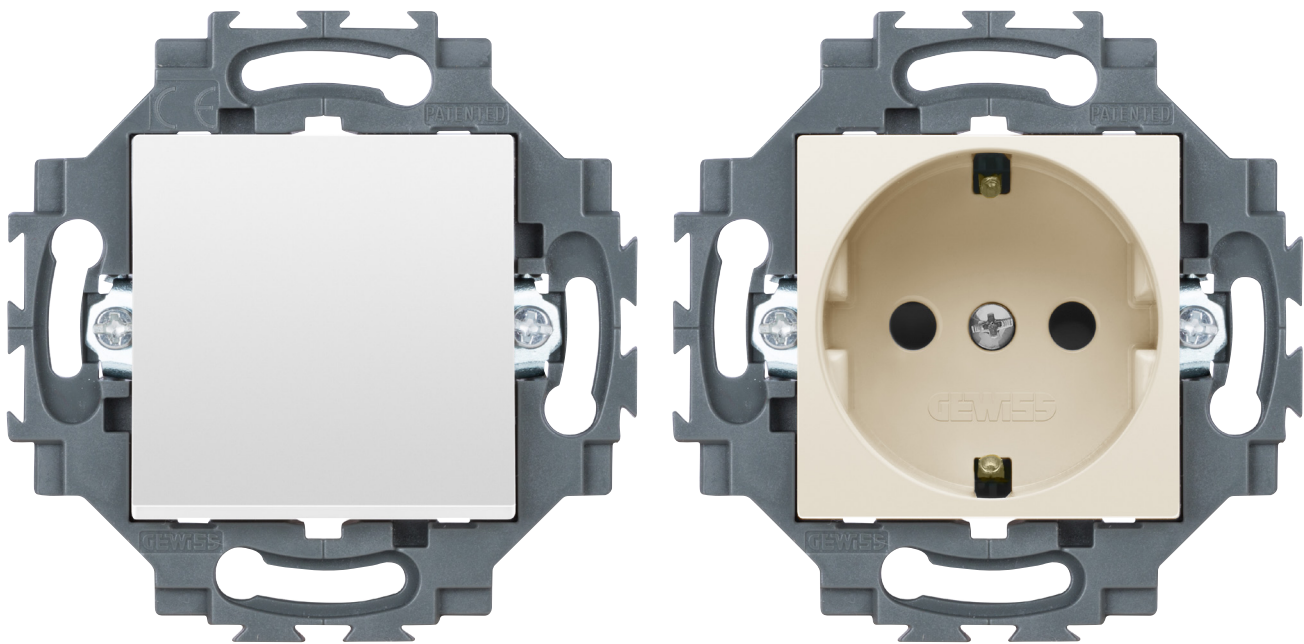

**DAHLIA**

Domestic range - Monobloc devices

**GEWISS**

## DAHLIA DEVICES

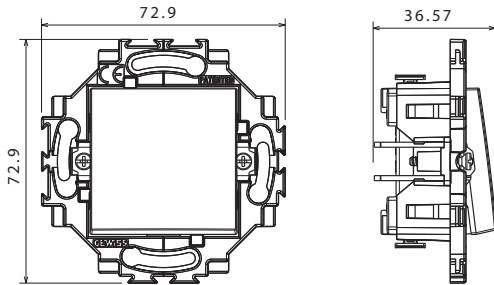

One-way switch - illuminable (screwless)  
GW 35 031 W - GW 35 001 Y

Two-way switch - illuminable (screwless)  
GW 35 071 W - GW 35 011 Y

Intermediate switch (screwless)  
GW 35 015 W - GW 35 015 Y

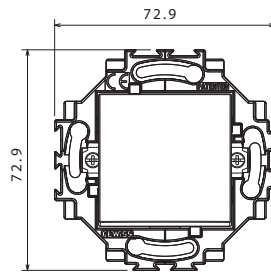

One-way switch - backlit (screwless)  
GW 35 002 W - GW 35 002 Y

Two-way switch - backlit (screwless)  
GW 35 012 W - GW 35 012 Y

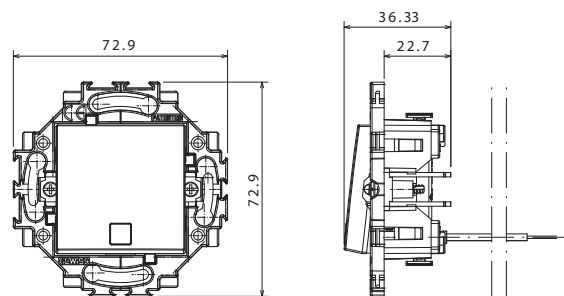
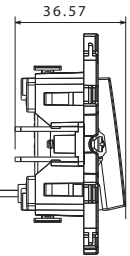

One-way switch with lens - backlit (screwless)  
GW 35 006 W - GW 35 006 Y

Two-way switch with lens - backlit (screwless)  
GW 35 016 W - GW 35 016 Y

Push-button with lens - backlit (screwless)  
GW 35 026 W - GW 35 026 Y

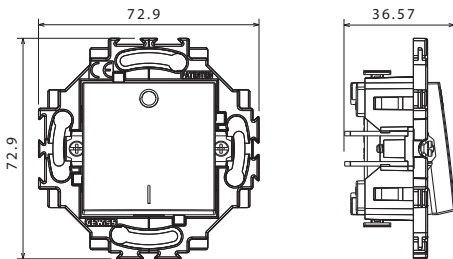

One-way switch 2P - illuminable (screwless)  
GW 35 003 W - GW 35 003 Y

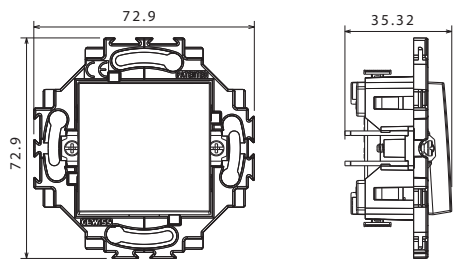

Push-button - illuminable (screwless)  
GW 35 021 W - GW 35 021 Y

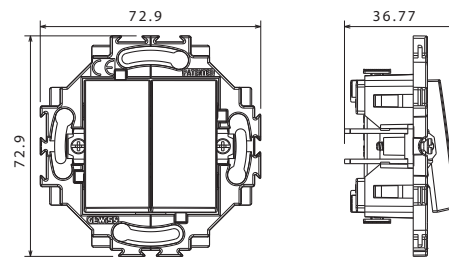

Double one-way switch (screwless)  
GW 35 051 W - GW 35 051 Y

Double two-way switch (screwless)  
GW 35 052 W - GW 35 052 Y

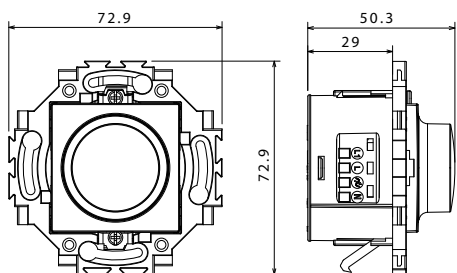

Universal dimmer (screw)  
GW 35 301 W - GW 35 301 Y

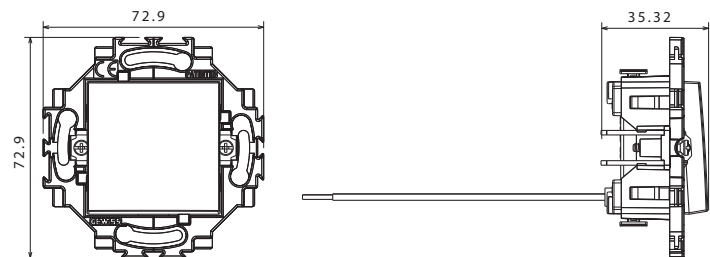

Push-button - backlit (screwless)  
GW 35 022 W - GW 35 022 Y

## DAHLIA DEVICES

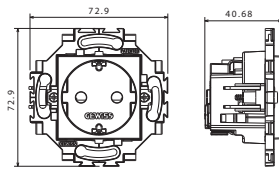

German std socket-outlet (screwless)  
GW 35 206 W - GW 35 201 Y

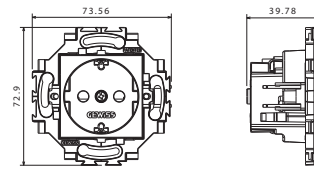

German std socket-outlet (screw)  
GW 35 207 W - GW 35 202 Y

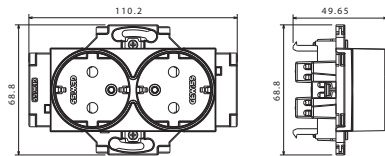

Double German std socket-outlet (screw)  
GW 35 204 W - GW 35 204 Y

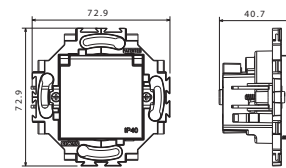

German std socket-outlet with lid IP40 (screw)  
GW 35 203 W - GW 35 203 Y

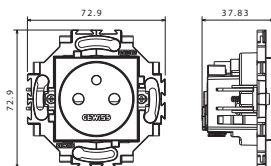

French std socket-outlet (screwless)  
GW 35 216 W - GW 35 211 Y

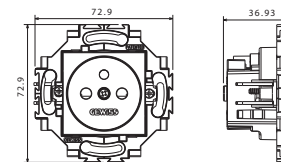

French std socket-outlet (screw)  
GW 35 212 W - GW 35 212 Y

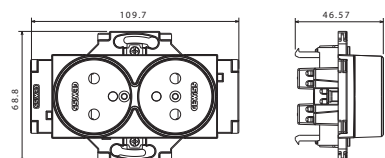

Double French std socket-outlet (screw)  
GW 35 214 W - GW 35 214 Y

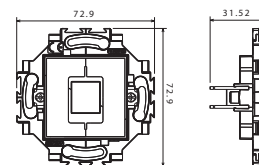

Keystone Jack empty enclosure  
GW 35 280 W - GW 35 280 Y

## DAHLIA ACCESSORIES

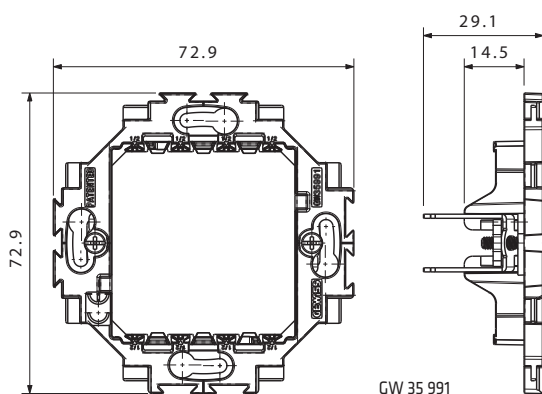

GW 35 991

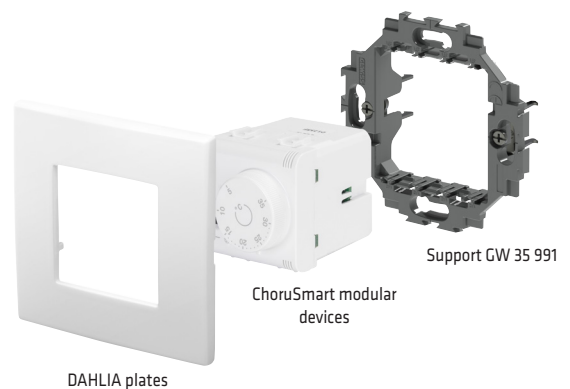

Support GW 35 991

ChoruSmart modular devices

DAHLIA plates

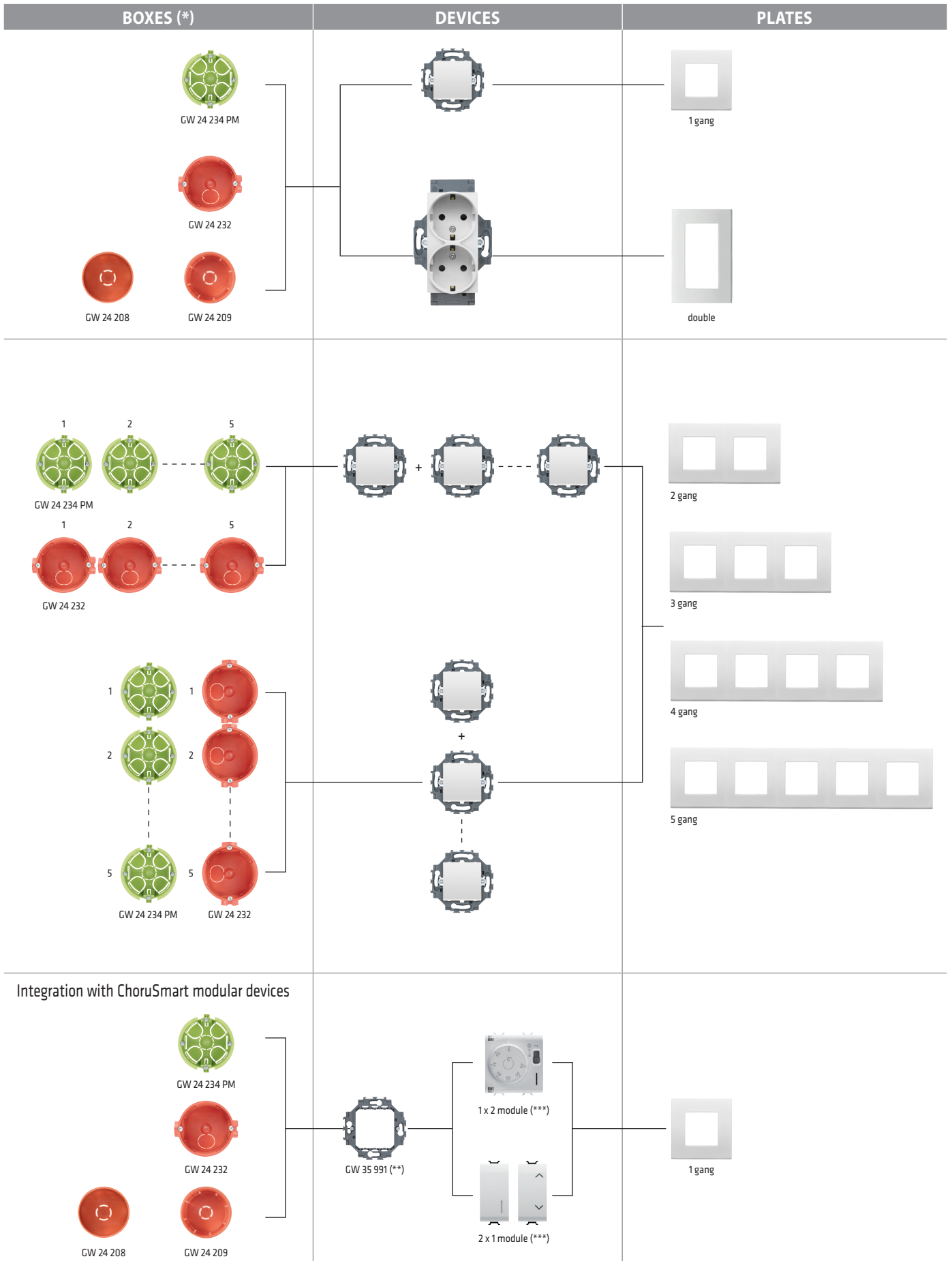

(\*) GW 24 231 Flush-mounting square boxes can be used only with screws (not with clutches)  
 (\*\*) The support GW 35 991 can be used individually or in array configuration, also in combination with the monobloc devices  
 (\*\*\*) From ChoruSmart modular devices range

**GEWISS S.p.A.**

Registered Office: Via Domenico Bosatelli 1

24069 Cenate Sotto (BG), Italy

**T** +39 035 946 111

**E** [gewiss@gewiss.com](mailto:gewiss@gewiss.com)

[www.gewiss.com](http://www.gewiss.com)

Single shareholder company - Bergamo Business Register/VAT/Tax Code (IT) 00385040167

Economic and Administrative Index 107496 - Share Capital 60,000,000.00 EUR fully paid up

Visit [www.gewiss.com](http://www.gewiss.com)  
and follow us on



**GEWISS**