

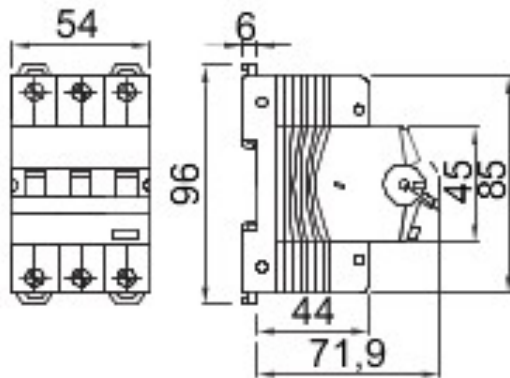

Omschrijving	AARDLEKSCHAKELAAR MET OVERSTROOMBEVEILIGING
Code	MDC 100
Aantal polen	3P
Aantal modules	3
Nominale stroom	6 A
Nominale restbedrijfsstroom	30 mA
Type	A
Curve	C
Nominale spanning (EN/IEC 61009-1, 61009-2-1)	230/240 V
Energy limiting class	3

Standaard	IEC/EN 61009-1, IEC/EN 61009-2-1	Nominale frequentie (Hz)	50/60 Hz
Afschakelvermogen EN 61009-1 230 V (Icn)	10000 A	Afschakelvermogen EN 61009-1 400 V (Icn)	10000 A
Afschakelvermogen EN 61009-1 (Ics)	0,75 x Icn	Afschakelvermogen EN 60947-2 230 V (Icu)	15 kA
Afschakelvermogen EN 60947-2 (Ics)	50% Icu	Isolatiespanning (Ui)	500 V
Immunitieitsniveau (8/20 μs)	250 A	Nominale stoot-houdspanning (Uimp)	4 kV
Overspannings-categorie	III	Elektrische weerstand	10000
Mechanische weerstand	20.000	Doorsnede starre kabel	<=1x35 - <=2x16 - <=1x16+2x10 mm <sup>2</sup>
Doorsnede flexibele kabel	<=1x35 - <=2x16 - <=1x16+2x10 mm <sup>2</sup>	Dubbel verbinding	JA (alleen stroomafwaarts)
Nominaal aandraaimoment	2 Nm	Bedrijfstemperatuur	-25 +60° C (derating of In with T>30° C)
Opslagtemperatuur	-40 +70 °C	Hulpmiddelen - compatibiliteit	Ja
Montage-positie	Elke		

### DIMENSIONAL



### WIRING DIAGRAM

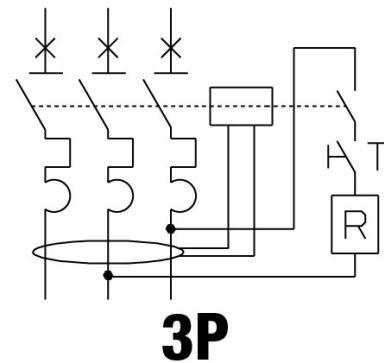

### STANDARDS/APPROVALS



