

ROAD [5] Range



Straatverlichtingsarmatuur met HIGH POWER LED, bestaande uit kap, frame en paalkoppeling met een laag kopergehalte EN AB 46100 gietaluminium met polyester poedercoating. Geschikt voor paalkop en zijbeugel in stappen van 5 graden kantelbaar. Open- en sluitsysteem met geïntegreerde fronthendel. Getemperd afdekglas (4 mm dik). Kabelingang PG13,5. Veiligheidsmes. Bekabelingsplaat in PA6.6+GF. Printplaat (PCB) met metalen kern. Optisch systeem van gemetalliseerd polycarbonaat. Overspanningsbeveiliging max. 10 kV (gemeenschappelijke modus). Kan worden gebruikt bij een omgevingstemperatuur van max. 50 ° C maar met geringere stromen zoals vermeld in de technische handleiding.

GENERAL INFORMATION		OPTIC AND ILLUMINATING FEATURES	
Context	Street and parking lighting	Optiek	HUGE
Luminaire	LED Road Equipment	Unified Glare Rating	G*4 - ULOR = 0
Toepassing	Extern	Lumenvermogen (lm)	24400
Unique digital code (Datamatrix)	Currently not present	Efficacy (lm/W)	131
Kleur	Grafietgrijs	Kleurtemperatuur	4000 K
Type lichtbron	LED	Colour Rendering Index	CRI>70
System power	186 W @ 0,85A	Standard Deviation Colour Matching	SDCM = 5
LED Lifetime	L90B10(Tq25°C)>115.000h; L90B10(Tq40°C)=115.000h	Photobiological Risk Class	RG0
Gewicht (kg)	9.1	Standaard	EN 60598-2-3, EN 60598-1 IEC/TR 62778
Garantie	5 jaar	ELETRICAL AND LIGHTING FEATURES	
Opslagtemperatuur	-	Voedingsspanning	220 - 240 V
Operating temperature	-25 +40 °C	Nominale frequentie (Hz)	50 / 60
MATERIALS		Driver failure rate	F10 = 100.000h Tq25°C/50.000h Tq40°C
Body	Gietaluminium	Driver	Included
Type plaat	4mm thick flat tempered glass	Overvoltage protection	DM 10KV / CM 10KV
Optic	Silver PVD aluminium reflector	Control System	DALI - 5 STEP
Gasket	Anti-aging silicone	INSTALLATION AND MAINTENANCE	
Locking Hook	Integrated front handle	Mounting and installation	Pole Head - Outreach
External screw	Roestvrij staal	Tilt	-20° + +10° zijbeugel - -10° + +20° paalbeugel
Colour	Powder coating	Wiring	Scheidingsschakelaar
STANDARDS AND APPROVALS		Bevestiging	Pole Head - Outreach
Classificering	-	Light source replaceability	By professional
Toestel met verlaagde oppervlaktetemperatuur	-	Controlgear replaceability	By professional
DIN 18032-3-certificering	-	Driver Box	Ingebouwd
IPEA	-	Maximum surface exposed to the wind	0.19 m²
Isolatieklasse	II		-
IP-graad	IP66		-
Stootbestendigheid	IK08		-
Glow Wire Test	-		-

DIMENSIONAL

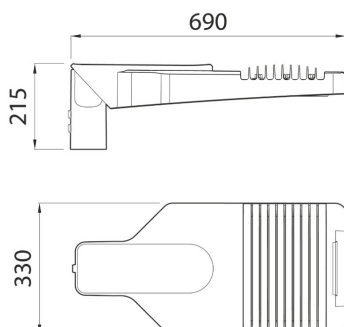

PHOTOMETRIC DISTRIBUTION

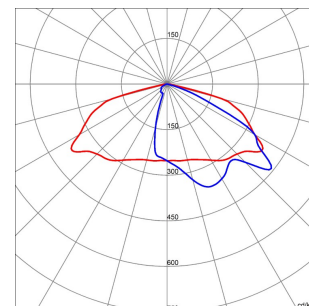

ROAD [5] Range

TECHNICAL SYMBOLOGY



0.19 m²



IP
IP66

IK
IK08

GWT
-

STANDARDS/APPROVALS

**UK
CA**

