

### ELIA FL



ELIA FL is an LED floodlight, available in medium and high-power versions for outdoor and indoor applications in industrial, tertiary and sports contexts, such as façades, warehouses, car parks and sports fields. Available in 4 different sizes and power steps (50 W, 100 W, 150 W and 200 W), the range allows for great flexibility with its multiple possible combinations: 3 colour temperature options (3,000 K warm white, 4,000 K neutral white and 5,700 K cool white) with a colour rendering index of more than 80; 2 integrated power supply options (On/Off and DALI); and 2 optics options (60° and asymmetrical). The luminaire can be ceiling, wall or floor-mounted through the integrated adjustable steel bracket with a protractor, or pole-mounted (in poles with diameter up to 61 mm) through a dedicated accessory (to be ordered separately). Thanks to its black powder-coated die-cast aluminium body and its front glass, the fixture is tough, durable (IP66 and IK08) and is able to withstand harsh environmental conditions (such as ambient temperature variations from -30°C to +50°C).

GENERAL INFORMATION		OPTIC AND ILLUMINATING FEATURES	
Context	Industry, logistics, facades, sporting facilities and outdoor area lighting	Optiek	Asymmetrisch
Luminaire	LED luminaire with mid and high lumen power	Unified Glare Rating	ULOR = 0%
Toepassing	Binnenshuis / buitenshuis	Lumen-vermogen (lm)	27600
Unique digital code (Datamatrix)	Currently not present	Efficacy (lm/W)	138
Kleur	Zwart	Kleur temperatuur	4000 K
Type lichtbron	LED	Colour Rendering Index	CRI 80
System vermogen	200 W	Standard Deviation Colour Matching	SDCM = 5
LED Lifetime	L80B50 (Tq=25°C) = 80.000 h	Photobiological Risk Class	RG1
Gewicht (kg)	4.8	Standaard	EN 60598-1; EN 60598-2-5; IEC/TR 62778; EN 62493
Garantie	5 jaar	ELETRICAL AND LIGHTING FEATURES	
Opslagtemperatuur	-40° +80°	Voedings-spanning	220-240 V
Operating temperature	-30°C ÷ +50 °C	Nominale frequentie (Hz)	50/60 Hz
MATERIALS		Driver	Ingebouwd
Body	Gietaluminium	Driver failure rate	F10 (Tq=25°C) > 80.000 h
Type plaat	Tempered 4mm-thick surface glass with Gewiss logo	Overvoltage protection	DM 4 kV/ CM 4 kV
Optic	High-efficiency lens and reflector unit	Control System	ON / OFF
Gasket	-	INSTALLATION AND MAINTENANCE	
Locking Hook	-	Mounting and installation	Floodlight mast - Ceiling - Wall - Ground
External screw	Stainless steel	Tilt	Rotation on bracket with integrated goniometer
Colour	Powder coating	Wiring	With power cable
STANDARDS AND APPROVALS		Bevestiging	Via integrated bracket
Classificering	-	Light souce replaceability	Non-replaceable
Toestel met verlaagde oppervlaktetemperatuur	-	Controlgear replaceability	By professional
DIN 18032-3-certificering	-	Driver Box	Ingebouwd
IPEA	-	Maximum surface exposed to the wind	0,095 m2
Isolatie-klasse	I		Ingebouwd
IP-graad	IP66		Ingebouwd
Stootbestendigheid	IK08		Ingebouwd
Glow Wire Test	750 °C		Ingebouwd

### DIMENSIONAL

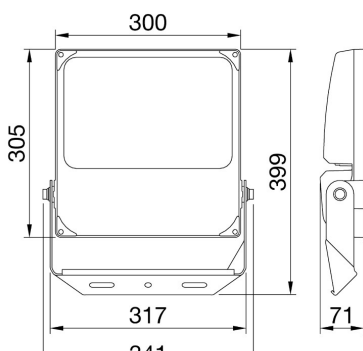

### PHOTOMETRIC DISTRIBUTION

ELIA FL

341

### TECHNICAL SYMBOLOGY



  
0,095 m2



**IP**  
IP66

**IK**  
IK08

**GWT**  
750 °C

### STANDARDS/APPROVALS

