

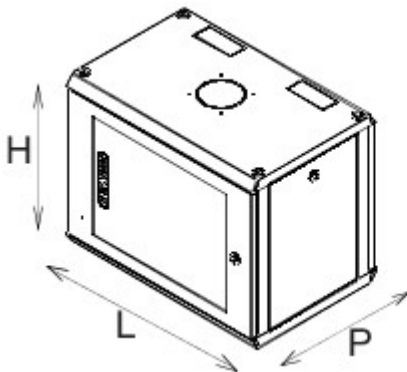

Complete system for the connection and distribution of LAN networks in residential and tertiary sector environments. The range includes fibre optic solutions, wall panels, floor cabinets and copper wiring products. Data Center boards and cabinets are available in a wide choice of modularity and different depths (up to 1000 mm), for adapting to every application need. Made with high quality materials (static flow at full load can reach 1000kg), the products are also characterised by their simple wiring (thanks to large internal volumes) and complete customisation, with removable and reversible front doors.

Categorie	19" wall-mount cabinet	Materiaal	Staal
Afwerking	Textured	Kleur	Grey (RAL 7035)
Bekabelings-eenheid	6 U	Type deur	Reversible
Door opening	180°	Static load capacity	50 Kilogramm
No. uprights	2	Diepte (mm)	400 mm
Buitenafm. LxHxD (mm)	600x335x400	IP-grad	IP20
Electrocod	3752		

DIMENSIONAL



	H	L	P	
GW 38 406	335	600	400	6U
GW 38 407	470	600	400	9U
GW 38 408	605	600	400	12U
GW 38 409	740	600	400	15U
GW 38 418	605	600	600	12U
GW 38 419	740	600	600	15U

TECHNICAL SYMBOLOGY

IP

IP20

STANDARDS/APPROVALS

