

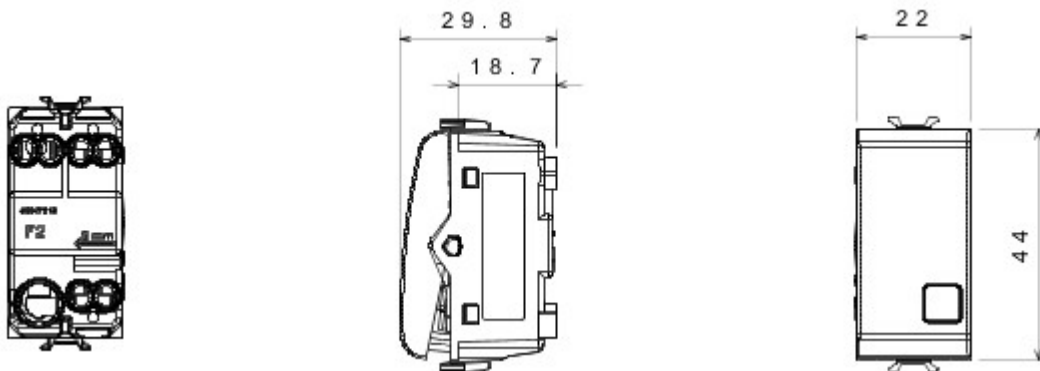

Wide range of control devices, sockets for power supply (conforming to national and international standards) signal pick-up, climate control, comfort management, technical alarm signalling and emergency lighting management. The ChoruSmart modular devices are available in five colours, glossy white, satin white, natural beige, satin black and lacquered titanium and in various sizes from 1/2, 1, 2 and 3 modules. Thanks to the mounting supports for rectangular, square and round boxes, endless combinations can be created with the ChoruSmart range of plates.

Categorie	Eenwegschakelaar	Knop	Met vervangbare neutrale lens
Kleur	Satin White	Omschrijving	1P - 16AX verlicht
Spanning	250 V AC	Standaard	EN 60669-1
Bestendigheid bij testspanning	2000 V bij 50 Hz gedurende 1 minuut	Rated power of 230V LED lamps	200 W
Isolatieweerstand	> 5 MOhm	Aansluitklemmen voor bekabeling	Met schroef
Verlengd bedrijf (aantal positiewijzigingen)	40.000 bij In 250 V AC cosφ=0,6	Thermospanning met kogel	125 °C
Gloeidraadproef	850 °C	Klemgreep op kabeltractie	> 50 N
Aanspanvermogen aansluitklem flexibele kabels (mm ²)	min. 0,75 - max. 2x4	Aanspanvermogen aansluitklem starre kabels (mm ²)	min. 0,5 - max. 2x2,5
Aantal modules	1	Materiaal	Technopolymeer
Electrocod	0130		

DIMENSIONAL



TECHNICAL SYMBOLOGY



STANDARDS/APPROVALS

