

Draaischeidingschakelaars



70 RT HP is a complete offer of rotary isolator switches from 16 A to 160 A, available in boxes both in insulating material and metal, in control or emergency versions, compatible with the main applications for residential, tertiary and industrial contexts.
 DC versions for photovoltaic applications are also available from 16 A to 40 A in insulating box.
 The series is completed with versions for board from 16 A to 800 A and for DIN rail fixing from 16 A to 63 A, which can be equipped with auxiliary contacts.
 The devices have been designed to reduce wiring time, facilitate installation and guarantee the maximum safety and robustness even in the most demanding conditions.

Stroomonderbreker	Rotary isolator	Uitvoering	Doos
Materiaal	Metaal	Type	Command
Nominale stroom (A)	40	Aantal polen	3P+N
Kleur knop	Zwart	Vergrendelbaar	YES (max. 3 locks in ON and OFF)
IP- graad	IP66	Stoot- bestendigheid	IK10 (box); IK08 (knob)
Omgevingstemperatuur	-25 +60 °C	Dekselschroeven (aantal en type)	4 metal screws
Current in AC21A (415V)	40	Gaten - ingang	2 x M20 + 2 x M25
Current in AC22A (415V)	40	Type accessoire	Max. 2 auxiliary contacts (1 per side)
Current in AC23A (415V)	40	Kabel- doorsnede	1-10 mm²



DIMENSIONAL

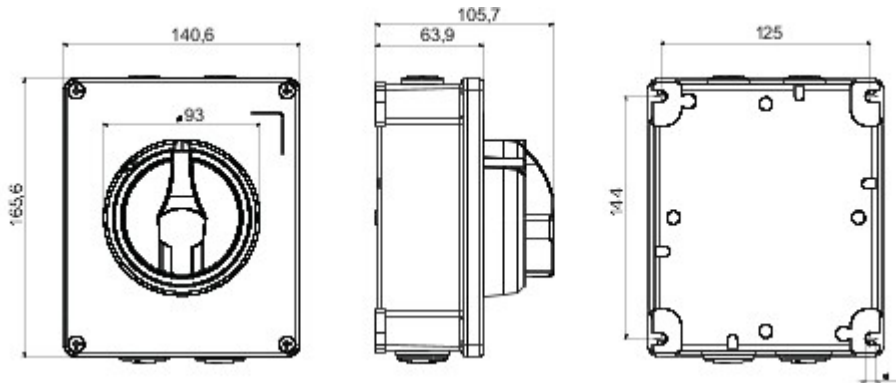

TECHNICAL SYMBOLOGY

IP

IP66

IK

IK10 (box); IK08 (knob)

STANDARDS/APPROVALS

