



70 RT HP is a complete offer of rotary isolator switches from 16 A to 160 A, available in boxes both in insulating material and aluminium, in control or emergency versions, compatible with the main applications for residential, tertiary and industrial contexts.

DC versions for photovoltaic applications are also available from 16 A to 40 A in insulating box.

The series is completed with versions for board from 16 A to 1000 A and for DIN rail fixing from 16 A to 63 A, which can be equipped with auxiliary contacts.

The devices have been designed to reduce wiring time, facilitate installation and guarantee the maximum safety and robustness even in the most demanding conditions.

ELECTRICAL CHARACTERISTICS		- Caractéristiques fonctionnelles		-
Organe de coupure	Interrupteur-sectionneur rotatif	Versions		Pour fixation sur rail DIN
Courant nominal (A)	16	Nb mod. EN 50022		4
Nombre de pôles	4P	Type		Commande
Courant en AC21A (415V)	16	Couleur poignée		Noir
Courant en AC22A (415V)	16	Verrouillable		Non
Courant en AC23A (415V)	16	ACCESSORIES		-
Section des câbles	1-10 mm ²	Type d'accessoire		Max. 2 contacts auxiliaires (1 par côté)

DIMENSIONS

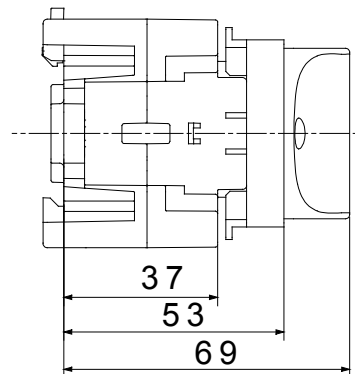
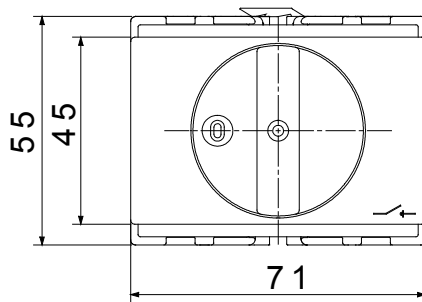

NORMES ET HOMOLOGATIONS

