

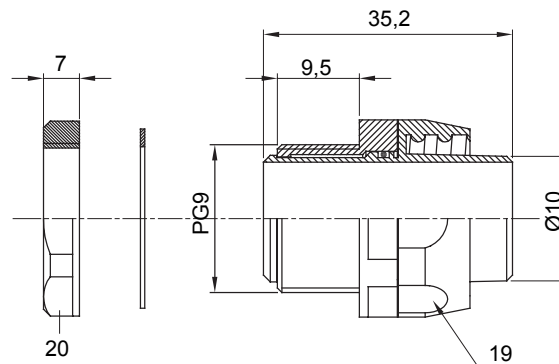

Raccord tournant droit pour gaine avec degré de protection IP54.

| | | | |
|---------|---------------|----------------------|------|
| Couleur | Gris RAL 7035 | Indice de protection | IP54 |
| Pas PG | 9 | Gaine Ø (mm) | 10 |
| Type | Tournant | Electrocod | 210 |

DIMENSIONS



SYMBOLE TECHNIQUE

IP

IP54

NORMES ET HOMOLOGATIONS

