

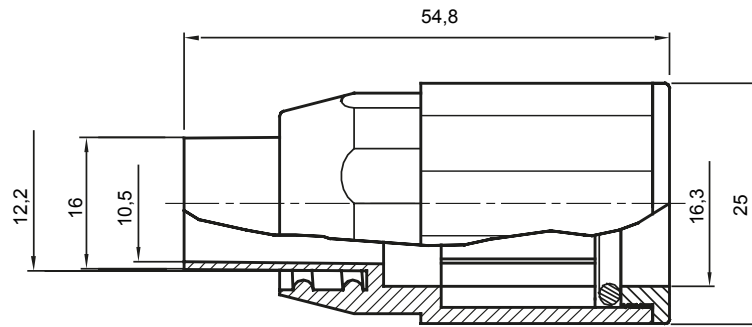

Routing components for rigid protective conduits with IP40 and IP67 protection degree.

Colour	Grey RAL 7035	IP degree	IP65
Conduits Ø (mm)	16	Sheath Ø (mm)	12
Type of material	Halogen free in compliance with EN 50642	Electrocod	21221

### DIMENSIONAL

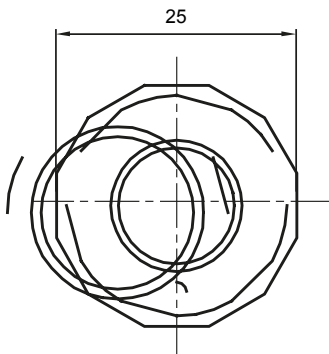

### TECHNICAL SYMBOLOGY

**IP**

**HF**  
HALOGEN FREE

IP65

### STANDARDS/APPROVALS

